

KÖNNER SÖHNEN

— ENERGY —

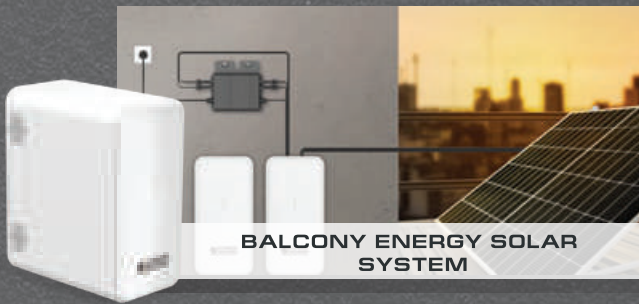

CONTENTS

ABOUT KÖNNER & SÖHNEN®	1
TURNKEY BUSINESS	6
ABOUT KÖNNER & SÖHNEN® – ENERGY	8
DC GENERATORS	10
BALCONY ENERGY SOLAR SYSTEMS	14
PORTABLE POWER STATIONS	18
PORTABLE SOLAR PANELS	22
POWERFUL PORTABLE POWER STATIONS	24
GASOLINE GENERATORS	30
• Gasoline generators with ATS System	36
• Gasoline generators with VTS System	40
• LPG/Gasoline generators	44
• Powerful gasoline generators 8,0 kW – 15,6 kVA	48
DIESEL GENERATORS	58
INVERTER GENERATORS	70
• LPG/GASOLINE inverter generators	78
DIESEL INVERTER GENERATORS	86
DIESEL POWER PLANTS	88
CORD REELS AND EXTENSION CABLES	96
DISTRIBUTION BOXES	98
K&S ACCESSORIES	100

DEAR KÖNNER & SÖHNEN® CUSTOMERS AND PARTNERS!

Thank you for your interest in our products. We hope that Könnér & Söhnen® equipment and accessories will become your reliable assistant!

Könnér & Söhnen® was created in Germany with the aim of producing high-quality, reliable equipment available for purchase by a wide range of consumers. Thanks to the many years of experience of our German specialists in the production of generators and garden equipment, we have created a series of products that meet "TRADITIONS OF GERMAN QUALITY" concept. This is exactly the standard of quality that is passed down from generation to generation, from the master (expert) to the students, from the father to the son, from the producer to the consumers.



Könnér & Söhnen® products have stood the test of time and meet the latest European and international standards of quality, efficiency, and environmental friendliness and cater to the needs of even the most demanding European customers.

With **more than 300 items** in 2024, Könnér & Söhnen® products are already available in **more than 20 European countries** and have been recognized by international experts and awards. We have established ourselves as a leading choice pari passu with internationally acclaimed brands and are recommended by the world-famous and regional partners.

We stay strong in pursuing our goals and keep up the tradition of German quality.

EXCLUSIVE K&S BRANDED ENGINE

All our products are based on our in-house upgraded range of high-performance engines designed by German engineers specifically for Könnér & Söhnen®. Könnér & Söhnen® engines have passed multi-stage tests and investigations, with all possible defects eliminated at the production stage. We purchased a license for the manufacture of our in-house range of Könnér & Söhnen® engines under the company logo and obtained all necessary certificates of conformity to European and international quality, efficiency and environmental standards, including the latest EURO 5 emission standard.

- Guaranteed power output
- Reinforced, wear-resistant parts
- Increased lifespan
- Multi-stage tests
- Serial number
- Own brand embossing

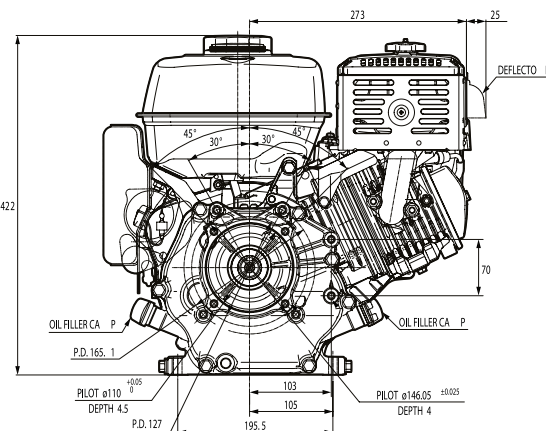

OWN BRAND EMBOSSING

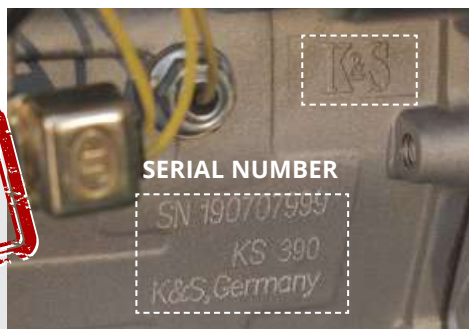

Each engine used in our generators, tillers and garden equipment has a unique serial number, allowing us to track the production and service quality.

KÖNNER & SÖHNEN® IN 2024

In 2024, Könnér & Söhnen® products are already available and in high demand in more than **20 European countries**. Additionally, they are already present in the United States and countries in Latin America, as well as in many countries in the Middle East (Turkey, Oman, UAE, Qatar, Israel) and African countries (Morocco, Egypt, Nigeria, Ethiopia). The company has **5 offices and 3 official representations**, its own service and production centers in Europe, and a well-developed dealer network.

Currently, our equipment is showcased in more than **500 sales outlets** and is commercially available to more than **500 million people**. Every year, we open up 3-5 new markets, set up official representative offices and significantly increase our turnover.



Head office:
 DIMAX International GmbH
 Flinger Broich 203, -FortunaPark-
 40235 Duesseldorf, Germany

● COMPANY OFFICES ● OFFICIAL REPRESENTATIONS ● AVAILABLE PRODUCTS



COUNTRIES WORLDWIDE



PRODUCT ITEMS



SALES OUTLETS



SERVICE SUPPORT



The Könnér & Söhnen® brand is dynamically developing and has interest in new business partners and sales markets.
Best regards, Könnér & Söhnen® team.

PRODUCT RANGE

Having identified all customer needs, we have carefully selected a range of products with the best features, ultimate reliability, and functionality to best meet the needs of our customers.

K&S ENERGY

- Balcony Energy Solar Systems
- Portable power stations, solar panels
- DC Generators
- AC Generators (gasoline, LPG/Gasoline, diesel, inverter)
- Diesel power plants



K&S GARDEN

- Battery-Powered Garden Tools (with lithium-ion battery):
 - Chainsaws
 - Lawn mowers
 - Brush cutters & string trimmers
 - Hedge trimmers
 - Leaf blowers & vacuums
- Electric garden tools:
 - Chainsaws
 - Brush cutters & string trimmers
- Log splitters
- Wood chippers
- Tillers (electric and gasoline)
- Water pumps
- Multifunctional machines 4 in 1



K&S CONSTRUCTION

- Vibratory plate compactors
- Tamping rammers
- Compressors



K&S AUTO

- Electric vehicle charging stations
- Jump starters
- Portable air compressors
- Car vacuum cleaners
- Automotive accessories



STATE-OF-THE-ART TECHNOLOGY

Keeping up with the changing technologies, Könnner & Söhnen® constantly updates its product range and introduces new technologies that not only add to the reliability, ecological compatibility and operational efficiency of our equipment but also meet the needs of our customers.



As we prioritize the environment, each product line has items featuring the latest eco-friendly technology. We offer the following products that help to reduce the environmental impact:

“ECO-FRIENDLY” ENERGY SOURCES

Balcony Energy Solar Systems from Könnner & Söhnen® are modern autonomous power supply systems that enable you to use your ordinary balcony as a source of clean and free solar energy.

Könnner & Söhnen® portable chargers and solar panels are “eco-friendly” innovative energy sources that produce no harmful waste during use and do not adversely affect the environment and the climate in general.

COMPATIBILITY “GREEN ENERGY”

Integration with green energy (solar/wind power plants) - direct current generators (24-54V) and generators with a built-in ATS system can be connected to a solar charge controller for automatic battery charging and electricity supply to the house.

EURO 5 – generators are based on K&S branded engines that meet the latest EURO 5 emission standard.

DUAL FUEL – models run on both LPG (propane-butane) and gasoline. LPG is more ecologically clean fuel than gasoline - ensures less emissions of harmful substances of exhaust gases into the atmosphere. LPG has a lower carbon footprint than gasoline and produces fewer exhaust emissions.

Innovative battery system for garden and construction tools “THE SINGLE BATTERY = MANY TOOLS”

Battery-powered garden and construction tools are eco-friendly devices that do not generate harmful waste during operation, having no impact on the environment and climate in the region. Using a SINGLE BATTERY FOR ALL TOOLS reduces waste and eliminates the need to dispose of numerous batteries, further contributing to a positive environmental impact. Also product group of Könnner & Söhnen® garden equipment includes models featuring eco-friendly electric motors.

QUALITY CONTROL AT EACH PRODUCTION STAGE

All Könnner & Söhnen® products are manufactured under the supervision of German engineers and tested at various stages of production. The customer service callback rate is therefore less than 1%.



CUTTING EDGE EQUIPMENT

- Quality control of purchased spare parts for compliance with European requirements, quality and safety standards;
- Quality control at the production and assembly stage.

IN-HOUSE SERVICE AND PRODUCTION FACILITIES IN EUROPE

- Control of each finished batch of goods before shipment;
- Quality control at our European in-house service and production center for clearance to sale.

QUALITY CERTIFICATES

Könnner & Söhnen® products have all necessary certificates of conformity to European and international quality standards, including the latest EURO 5 emission standard.



INTERNATIONAL AWARDS

We take pride in the high quality and reliability of **Könnner & Söhnen®** equipment recognized by international experts and prestigious awards. Fastidious and demanding German technical innovation experts have thoroughly examined and tested our products and concluded that the manufacturer Könnner & Söhnen® offers its customers reliable products that are different from the mass-produced ones. They also emphasized some exclusive product innovations and ease of use.



FORBES DIAMONDS 2023

Poland • 2023

The Forbes magazine has awarded the **Forbes Diamonds 2023** title to DIMAX International Poland Sp. z o. o. as the fastest growing company which have chosen the right business strategy. The strategy of forming the product range with an emphasis on cutting-edge technologies and the development of new exclusive technologies, as well as the intelligent corporate structure and interaction both within the company and beyond enabled it to achieve this success.



EXCELLENT BRANDS

Germany • 2022

In 2022 Könnner & Söhnen® was announced the winner of the **German Brand Award'22** competition in two nominations:

- Excellent Brands - Industry, Machines & Engineering
- Excellent Brands - Product Brand of the Year

Among the 1,200 submissions from exclusively German brands, the unbiased experts honored Könnner & Söhnen® products in two Excellent Brands categories: "Industry, Machines & Engineering" and "Product Brand of the Year." The evaluation criteria are transparent and openly communicated.



PLUS X AWARD

Germany • 2019

In 2019, Könnner & Söhnen® products won the prestigious German **Plus X Award** in three nominations:

- High Quality
- Ease of Use
- Functionality

Plus X Award is one of the most renowned awards in the world that ascertains the quality and reliability of products. German experts confirmed that products from Könnner & Söhnen® meet the requirements for high-quality products and stated that the equipment is tailored to even the most demanding customer needs.



GOLD MEDAL

Poland • 2018

In 2018, Könnner & Söhnen® products received the prestigious **Gold Medal Award in the Expert Choice nomination in Poland.**

Könnner & Söhnen® equipment was recognized by experienced European experts and professionals as equipment that meets the requirements of advanced technologies. This award attests to quality of products and high production potential of Könnner & Söhnen®.



PRODUCT OF THE YEAR

Ukraine • 2016

Könnner & Söhnen® products won the 2016 **UKRAINIAN NATIONAL OLYMPUS** award as the **BEST PRODUCT OF THE YEAR** in the **Garden Equipment & Generators** category based on value for money. The Könnner & Söhnen® brand has occupied its niche in the medium price category, offering buyers high-quality goods with all European certificates at an affordable price.

BUSINESS CHEETAH

Poland • 2022

Dimax International Poland Sp. z o.o. (Poland) was distinguished by the European Business Institute in the 17th edition of the Business **Cheetahs 2022 competition**, the 15th edition of the Diamonds of the **Polish Economy 2022** competition, the 15th edition of the **Efficient Company 2022** competition, and the 10th edition of the **Strong Company 2022** competition based on financial data from the National Court Register.



Diamond of the Polish Economy statuette



Business Cheetah statuette



Efficient Company 2022 statuette



Strong and Trustworthy Company statuette

The company is growing dynamically, achieving an average income and net profit growth rate of 454.8% in the years 2019-2020, earning it the title of "**Business Cheetah 2022.**" Additionally, the company's effective operations were confirmed by an average net profit to income ratio of 10.7% in the years 2019 and 2020, earning it the title of "**Efficient Company 2022.**" As a result, the company also earned the title of "**Strong and Trustworthy Company 2022.**" The market value of the company was estimated at PLN 61 million in March 2021, earning it the title of "**Diamond of the Polish Economy 2022.**" The company sells high-quality devices of the German brand Könnner & Söhnen® at affordable prices.

BENEFITS FOR DEALERS

Thanks to a team of professionals with many years of experience in developing and selling equipment, we know exactly the needs of each sales channel and provide our partners with a complete package of necessary materials. We create all the necessary conditions for your successful sales. That is why Dimax Group provides comprehensive after-sales support to customers throughout the sales territory.

✓ TIME-PROVEN QUALITY PRODUCTS TESTED BY DEMANDING EUROPEAN CUSTOMERS

Our products have received numerous awards and wide recognition for both their quality and affordability.

✓ INTERNATIONAL CUSTOMER & PARTNER SUPPORT

- full after-sales service
- professional advice on any technical issues
- manuals, photos and videos with detailed instructions for use of the equipment
- staff product range training

✓ WARRANTY AND AFTER-SALES SERVICE

- customer service with original spare parts
- 2-year limited warranty

✓ PRE-SALES ASSESSMENT

For each finished batch of goods, a part of the goods undergoes testing at our in-house service and production center in Europe to verify compliance with the specifications approved by Könnner & Söhnen® engineers and to issue a certificate of approval for sale.

✓ MARKETING AND DESIGN DEPARTMENT

We provide a complete set of marketing and information materials: photos, videos, 3D reviews, promotional POS and WEB materials (catalogs, booklets, promotional mailings, banners, assistance in branding exhibition halls, website development and technical support services.)



HIGH QUALITY

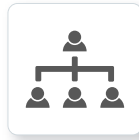

WIDE SEGMENT OF BUYERS



STAFF TRAINING



AFTER-SALES SUPPORT



COMFORTABLE TERMS OF COOPERATION



PRE-SALE PREPARATION

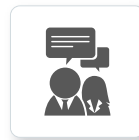

FULL MARKETING SUPPORT



TOP-NOTCH CUSTOMER SERVICE

CHOOSING KÖNNER & SÖHNEN®, YOU BECOME PART OF A LARGE-SCALE COMPANY AND GET A TURNKEY BUSINESS

100% SERVICE SUPPORT

We provide 100% customer support and after-sale service throughout the sales area.

INTERNATIONAL CUSTOMER & PARTNER SUPPORT

- professional advice on any technical issues
- full after-sales service
- staff product range training

VIDEO INSTRUCTIONS ON HOW TO USE OUR PRODUCTS

- commissioning
- start-up
- explanation of individual functions
- other useful tips

WARRANTY AND AFTER-SALES SERVICE

- high-quality service with original spare parts
- international warranty



WE ARE INTERESTED IN YOUR SUCCESS! WELCOME TO COOPERATION!

GROWING BRAND RECOGNITION

Our fast-growing company has potent promotion and strong sales positions in every market it enters. Every year, we participate in leading trade shows worldwide.



**GERMANY
COLOGNE**
2016 · 2018
2022



**TANZANIA
DAR ES SALAAM**
2022



**POLAND
POZNAN**
2018 · 2019



**POLAND
POZNAN**
2016 · 2017
2018 · 2019



**KENYA
NAIROBI**
2022



**UAE
DUBAI**
2018 · 2022



**POLAND
WARSAW**
2018



**ETHIOPIA
ADDIS ABABA**
2023



**EGYPT
CAIRO**
2022

WE ARE TRUSTED BY

Customer trust is a cornerstone of the further effective development of any business. We value every customer and are proud to be recommended by globally known trading partners.



CUSTOMER DIVERSITY

We have created a range of products with the best features for the most demanding customers. Könnér & Söhnen® products are suitable for both domestic and commercial applications.

They have the best value for money!

 ADDICKS & KREYE CONTAINER SERVICE GMBH CONTAINER SERVICE	 LUGS MASSIVHAUS GMBH CONSTRUCTION COMPANY	 BLUMENTRITT MEDIZINTECHNIK/ INH. THOMAS MATZIK MEDICAL EQUIPMENT MANUFACTURER	 THÜNEN - INSTITUT FÜR AGRARKLIMASCHUTZ INSTITUTE OF AGRICULTURE FOR GLOBAL WARMING
 GERICKE NUTZFAHRZEUGSERVICE UND FAHRZEUGBAU GMBH TRUCK REPAIR	 QUAST WASSERTECHNIK SWIMMING POOL REPAIR	 FISCHBACHER GMBH+CO. KG CONSTRUCTION EQUIPMENT	 HERIBERT & HEIDI HAUSER COTTAGE TOWN
 CATHERINE LEBLANC FITNESS CENTER	 QUAD ET MOTO GENTIANE LASCOURTINES SOLUTIONS FOR MOTORCYCLES AND FOUR-WHEELERS	 JSC "UKRTELECOM" UKRAINE'S LARGEST FIXED LINE TELECOMS PROVIDER	 STATE EMERGENCY SERVICE OF UKRAINE EQUIPMENT FOR FIRE MACHINES
 "STEPHANE REA LA PETITE" FRENCH CUISINE RESTAURANT	 FURNIDE LOJA GUEST HOUSE	 JSC "UKRAINIAN RAILWAY" UKRAINE'S LARGEST PASSENGER AND CARGO CARRIER	 „112 UKRAINE" INFORMATION TV CHANNEL



Könner & Söhnen – ENERGY

Products from the **Könner & Söhnen - ENERGY** category, are not just backup energy sources - they are innovative solutions that make the world better.

One of the most urgent issues today is the possibility of unexpected interruptions in central power supply. In the modern world, being without electricity means not only being without lighting, water, and heating but also without information and communication with loved ones. Könner & Söhnen - ENERGY products from Könner & Söhnen® are the perfect solution for unexpected circumstances.

The wide range of products in the Könner & Söhnen - ENERGY category includes over 100 units of the latest generation for solving power supply issues in both private and professional settings: for homes, apartments, business facilities, workshops, camping, events, and much more.

Our engineers are constantly working on implementing the latest technologies in Könner & Söhnen® products to ensure their maximum efficiency while preserving natural resources. We value the environment and strive to minimize the impact of our products on the surroundings.

Therefore, in 2024, we are expanding the product line of eco-friendly energy sources, which will not only help preserve our planet but also save money.

- ✓ **Cutting-edge autonomous power supply systems - balcony solar systems.**
- ✓ **Modern energy storage systems - portable chargers.**
The use of renewable energy sources contributes to environmental conservation.
- ✓ **Direct current generators are the best solution for alternative power systems with 24-54 V batteries. These are not just generators but truly charging generators with automatic output current regulation. They are ideal for charging batteries in the field of ensuring energy independence for private households, autonomous, solar, wind, telecommunication systems, uninterruptible power supply systems, and other systems using high-capacity batteries.**

Furthermore, within the Könner & Söhnen - ENERGY product range, we offer consumers an exceptionally wide variety of alternating current generators with unique functionalities, some of which have no equivalents among other manufacturers:

- ✓ **Gasoline, LPG/gasoline, diesel generators - reliable generators with a variety of capacities ranging from 2.5 kW to 15.6 kVA.**
- ✓ **Inverter generators with exclusive features, unparalleled capabilities, and providing a wide range of functional solutions for backup power.**
- ✓ **This year, we have expanded our range of gasoline and LPG/gasoline inverter generators, which produce maximum pure current with models that run on diesel fuel - these rare devices have an extended engine lifespan and, at the same time, feature fuel-saving functionality.**
- ✓ **Diesel power stations from the HEAVY DUTY series, based on low-speed 4-cylinder engines with water cooling, ranging in power from 16 to 33 kVA.**

All products in the Könner & Söhnen - ENERGY category are modern, highly efficient devices that meet the highest international quality standards. These top-quality products have already proven themselves in more than 20 European countries, characterized by long-lasting and reliable operation.



DC GENERATORS

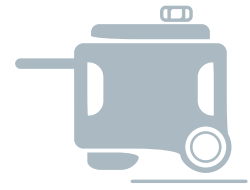

BALCONY ENERGY SOLAR SYSTEMS

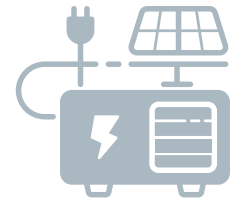

PORTABLE POWER STATIONS



AC GENERATORS



DIESEL POWER PLANTS





DC GENERATORS

 24 – 54 V (≤ 70 A)



Direct current generators from Könnert & Söhnen® are the best solution for modern alternative power systems. These are not just generators but truly charging generators with automatic output current regulation!

The generator is to be used as a backup power source for systems with 24-54 V batteries. Such batteries are typically used in solar power systems, wind power systems, UPS systems, mobile communication base stations, surveillance systems, and in other spheres of automotive and construction equipment.

SOLAR OR WIND POWER PLANTS



THIS GENERATOR CAN BE INTEGRATED WITH VARIOUS SYSTEMS.

IT CONNECTS DIRECTLY TO THE BATTERY, WHICH SIGNIFICANTLY SIMPLIFIES INSTALLATION.

DC GENERATOR



24-54 V BATTERY



PORTABLE SOLAR POWER STATION



CONSUMERS



POWER SUPPLY



SIMPLE INSTALLATION

- ✓ The generator connects directly to the battery, which significantly simplifies installation.
- ✓ The possibility of external control of «dry contacts» significantly expands the possibilities of integrating the generator into existing power supply systems.

DIRECT CURRENT GENERATORS FROM KÖNNER & SÖHNEN® - THE MOST EFFICIENT BATTERY CHARGING SYSTEM:

✓ MAXIMUM EFFICIENCY

This method of charging is more efficient since there are no intermediate current conversions and associated with this energy losses, thanks to this, **the efficiency coefficient is twice as high**. This generator charges the battery with direct current, while an AC generator charges with pulses.

✓ FAST CHARGING

Charging is twice as fast as in a system with a conventional generator. The charging power of this generator equals the charging power of a regular AC generator with a double capacity (7-8 kW), as well as the charging power of ten solar panels in the summer!

✓ COST-EFFICIENT CHOICE

Over 50% fuel savings - this generator needs to operate half the time compared to a conventional one. Additionally, it adjusts the engine speed based on the battery charge, enhancing fuel savings and extending the generator's lifespan.

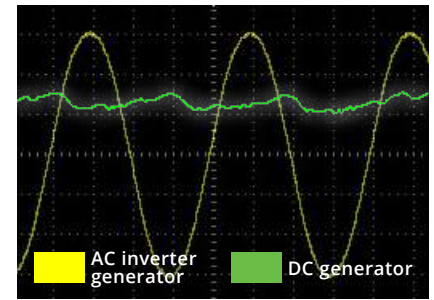

MAXIMUM CURRENT EFFICIENCY

DC GENERATOR

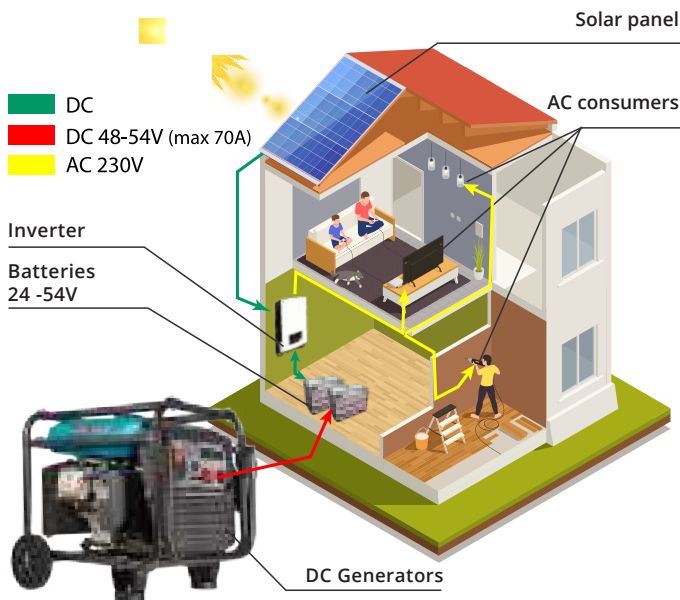

✓ AUTOMATIC START

With the integrated controller, the generator constantly monitors the battery voltage in AUTO mode and automatically starts charging the battery when its voltage drops.

✓ SAFE USE

The absence of life-threatening high voltage protects the user from electric shock while using the generator.

✓ COMPACT SIZES AND HIGH POWER

High charging power in a small size generator - the generator is designed by analogy with the inverter type of generators. It takes up 3-5 times less space than a set consisting of regular 230V generator with alternating current and a powerful charger that converts 230V alternating voltage into a direct voltage for battery charging. Equipped with a transport kit for easy movement.





DC GENERATORS

KS 24V-DC

Current (max)	50 A
Voltage	24 - 27 V
Engine start	manual/auto/external
Net dimensions (LxWxH)	500×285×460 mm
Net weight	19 kg



KS 48V-DC

Current (max)	70 A
Voltage	48 - 54 V
Engine start	manual/auto/external
Net dimensions (LxWxH)	510×525×310 mm
Net weight	36.5 kg



KS 48V-DC S

Current (max)	70 A
Voltage	48 - 54 V
Engine start	manual/auto/external
Net dimensions (LxWxH)	620×440×510 mm
Net weight	40 kg



Models KS 48V-DC, KS 48V-DC S are equipped with a transport kit (fold-out handle and wheels), enabling its easy handling and expanding its range of applications.

You can connect multiple generators in parallel to increase overall power or provide longer battery power supply.

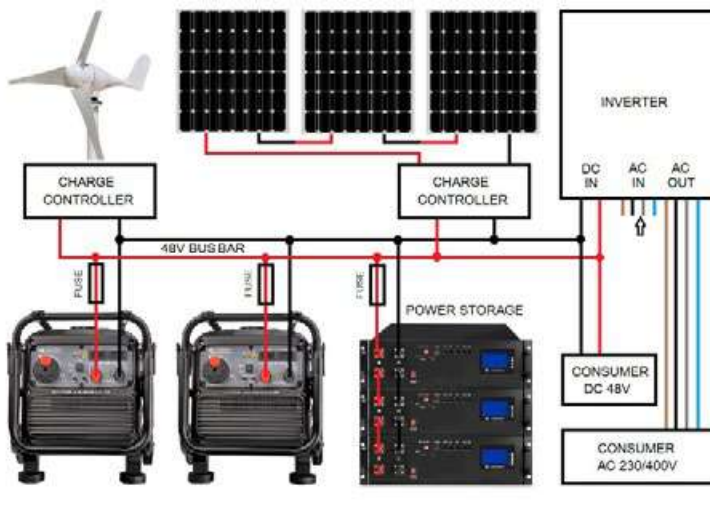

- ✓ The generator is connected in parallel to the battery, it can itself monitor the battery voltage in auto mode. Generator starts and stops automatically if necessary.
- ✓ In external mode, the generator is controlled externally by external "dry contacts" (e.g. inverters with programmable "dry contacts"), which significantly expands the generator's range of applications.

The generator is equipped with a system to monitor all key operating parameters, including protection against overloads, short circuits, and low oil level. The appropriate indicators are located on the generator panel.

SAMPLES OF APPLICATION



INVERTER FOR SOLAR AND WIND POWER PLANTS



ELECTRONIC MODULES WITH 48V BATTERIES



UNINTERRUPTIBLE POWER SUPPLY (UPS)



BALCONY ENERGY SOLAR SYSTEMS

 2240 Wh

Introducing our latest innovation: Balcony Solar Systems of the latest generation in 2024 from Könnert & Söhnen® – offering maximum efficiency in solar energy conversion and guaranteed productivity even after 30 years.

Balcony Energy Solar Systems from Könnert & Söhnen® are modern autonomous power supply systems that enable you to use your ordinary balcony as a source of clean and free solar energy. This means that you can generate your own electricity without occupying extra space and without investing significant funds in complex installations.

SUPPORTS MAXIMUM POWER POINT TRACKING (MPPT) TECHNOLOGY – MAXIMIZING POWER POINT TRACKING. VERY HIGH CHARGING EFFICIENCY.



Könnner & Söhnen® Balcony Energy Solar Systems - these modern systems are based on the „Smart Battery Block“ with high-capacity LiFePO4 lithium iron phosphate batteries, offering a long service life and doubling the number of recharge cycles compared to lithium-ion batteries.

Battery capacity	Cycle times	To the balcony solar system	APP Control
LiFePO4			
2240 Wh	≤ 6000 TIMES	2xMC4 in, 2xMC4 out.	THROUGH THE APP

INTELLIGENT ENERGY STORAGE SYSTEM



- ✓ Real-time display of charging, discharging, and other status
- ✓ Various charging settings
- ✓ Adjustment of the output power for each line depending on the time period

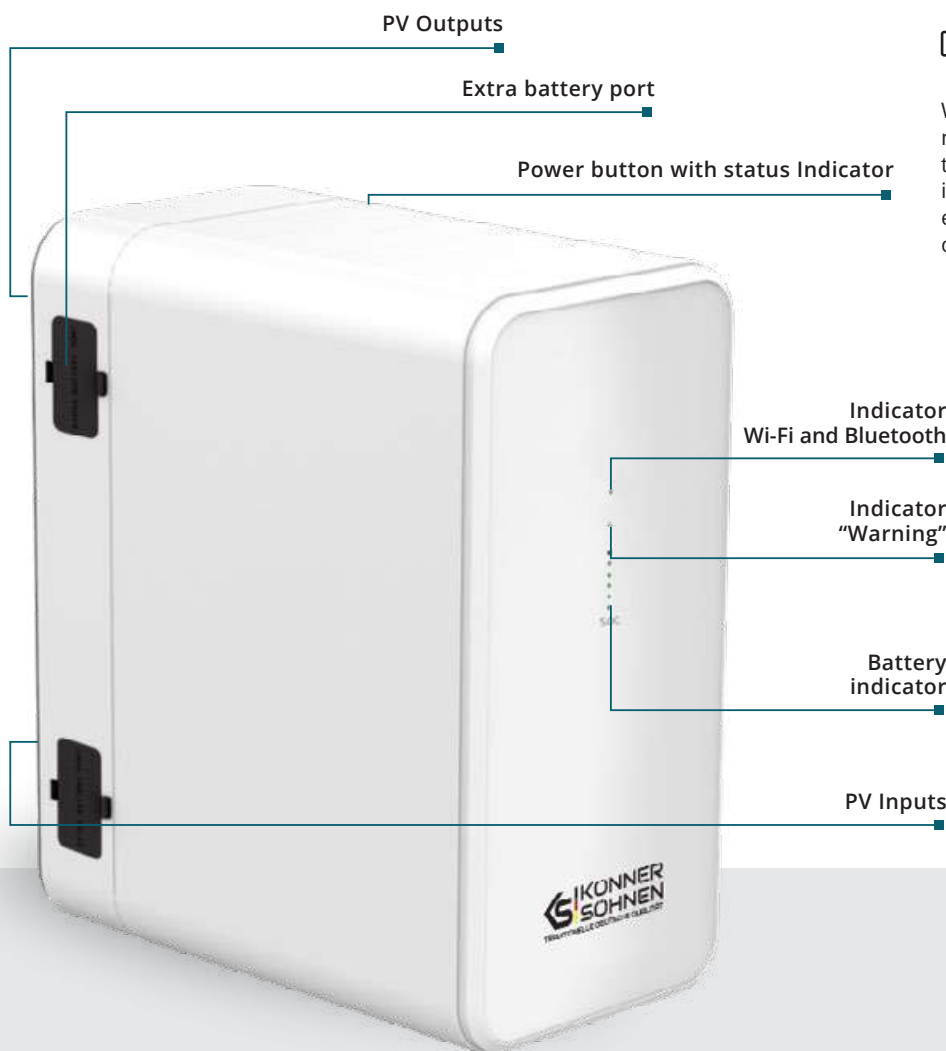

We value the environment and strive to minimize the impact of our products on the external surroundings. Therefore, we implement cutting-edge technologies that enable us to reduce the harmful influence on the environment.



APP CONTROL - THE ABILITY TO CONTROL FROM A MOBILE DEVICE

BALCONY ENERGY SOLAR SYSTEMS



BALCONY ENERGY SOLAR SYSTEMS

The battery units for the balcony system from Könnert & Söhnen® have the capability of parallel connection, enabling you to increase power and energy reserve.



With our Balcony Energy Solar Systems, you not only gain access to environmentally friendly energy but also have the opportunity to significantly reduce electricity costs.

- ✓ Autonomous power supply system using free solar energy
- ✓ Doesn't take up much space
- ✓ No need to buy expensive stationary equipment
- ✓ Easy installation

SAFETY SYSTEMS



Overload protection



Short circuit protection



Overcurrent protection



Overdischarge protection



Overvoltage protection



Overheat protection

KS 2240BSB

Capacity	2240 Wh (50 Ah / 44.8 V)
Battery Type	LifePO4 Batteries
Cycle times	≤ 6000 times (80% DOD)
PV MC4-Input×2	12-59 V / 8.47 A 2x500 W max.
DC MC4 Output×2	42-50.4 V / 9.52 A 2x400 W max.
Input for connecting an additional battery×2	at the Input 44.8-51.1V max. 35A, per Output 42V-51.1V max. 30A
System management	OVP, UVP, OCP, SCP, OTP, UTP, etc
Wireless	BT5.2 + WIFI 2.4G
Working temperature	-10 °C + 50 °C
Net Dimensions (LxWxH)	350×175×295 mm
Net Weight	18.7 kg
Protection class	IP65



MICROINVERTER

KS MI800W

Maximum input Voltage (DC)	60 V
Range of input operating voltage (DC)	25~55 V
Maximum input current	2x13 A
Operating voltage range (AC)	230 V
Rated output current (AC)	3.5 A
Max output apparent power	800 VA
Rated output power	800 W
Rated AC Grid Frequency	50/60 Hz
Ambient Temperature	-20°C +65°C
Peak efficiency	96.5%
Protective class	Class I
Ingressprotection	IP67
Gross dimensions (LxWxH)	440×286×68 mm
Net / Gross weight	3/4.4 kg



Single-phase inverter

- ✓ High Efficiency up to 96.5%
- ✓ Built-in WIFI Monitoring
- ✓ IP Level: IP67

SOLAR PANELS (set of 2 solar panels 430 W)

KS SP430-HC

Maximum Power (Pmax)	430 W
Voltage at Pmax (Vmp)	31.88 V
Current at Pmax (Imp)	13.49 A
Open-Circuit Voltage (Voc)	38.49 V
Short-Circuit Current (Isc)	14.23 A
Maximum System Voltage	1500 V
Maximum Series Fuse Rating	25 A
Fire Rating	Class C
PV Module Classification	Class A
Pmax/Voc/Isc Toleranc	±3%
Gross dimensions (LxWxH)	1722×1134×60 mm
Net / Gross weight	44.5/46.5 kg



- ✓ Silicon PV Module
- ✓ TOPCon technology
- ✓ Half-cut cell type

*Tested at STC1000W; AM1.5; Cell temperature 25°C

SOLAR PANEL MOUNTS

(set of 2 solar panel brackets) KS BSP2

Our solar panel mounts will help you maximize space efficiency on your balcony. You can choose between two installation options: directly on the balcony, enabling panels to be angled towards the sun, increasing their efficiency, or outside the balcony - in this case, they become almost invisible, and your balcony remains fully available for you.





PORTABLE POWER STATIONS AND SOLAR PANELS

 300 – 3000 W



Portable charging stations from Könnner & Söhnen® are not only a source of instant energy but also an ideal solution for those who value peace and environmental safety. You can use them indoors, in close proximity to people and animals, and it is absolutely safe because they produce no noise and, more importantly, do not emit harmful carbon monoxide (CO).

Könnner & Söhnen® portable chargers and solar panels are “eco-friendly” energy sources that produce no harmful waste during use and do not adversely affect the environment and climate change in the region. It works quietly and efficiently powers up your electrical devices as you enjoy your time without any disturbing noise.

POWER UP YOUR LIFE WITH KÖNNNER & SÖHNEN®!



Powerful models of portable chargers (KS 1200PS and KS 2400PS) come with a LiFePO4 battery fast-charging device that charges the station quickly and safely. In just 2 hours, the battery reserve will be replenished, and the station will be ready for operation.



Portable power stations Könnner & Söhnen® are equipped with Power Delivery technology, which ensures fast charging batteries of modern smartphones and even laptops.



We value the environment and strive to minimize the impact of our products on the external environment. Therefore, we implement cutting-edge technologies that enable us to reduce the harmful impact on the environment.

With these devices, you can easily charge your electrical or digital devices while traveling or when there is no mains supply. The units have USB ports and DC and AC outputs. With no mains supply, you can charge laptops, cell phones, tablets, drones, use household appliances, lighting equipment, etc.

Portable power stations from Könnér & Söhnen® are now produced using **high-quality LifePO4 lithium iron phosphate batteries** with a high capacity. These batteries have a higher energy density, compared to Li-ion, so they can store more energy in a compact format. In addition, they have a longer lifespan because these batteries have a double number of recharge cycles compared to lithium-ion batteries.

Rated power



300 - 2400 W

Battery capacity



294 - 2240 Wh

Outputs for connecting



6 - 11 DEVICES

Pure sine wave



SUITABLE FOR SENSITIVE DEVICES

- ✓ Long lifespan
- ✓ A double number of recharge cycles
- ✓ High capacity



Maximum Power Point Tracking (MPPT) - is an intelligent management system that continuously monitors and finds the maximum power point in your solar system. This means that even with changes in lighting and temperature, you will get the maximum energy from each solar cell.

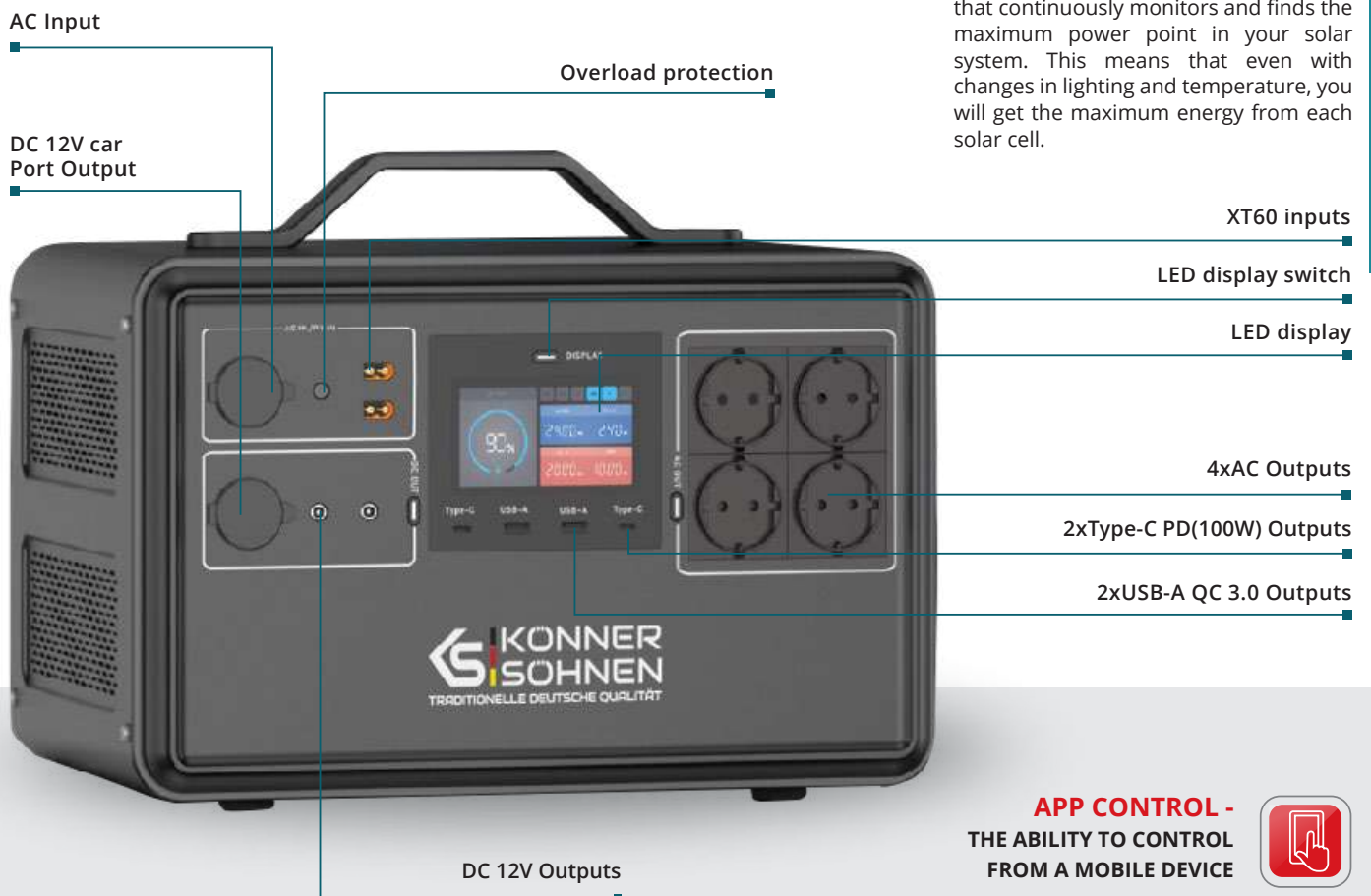

APP CONTROL - THE ABILITY TO CONTROL FROM A MOBILE DEVICE

PORTABLE POWER STATIONS



PORTABLE POWER STATIONS

POWER UP YOUR LIFE WITH KÖNNER & SÖHNEN®!

A silent portable power station is an indispensable assistant, which helps to power your home in emergencies and make your outdoor activities more comfortable. When hiking, fishing, hunting, or camping, the portable power station will allow you to power your electrical devices and simply enjoy your time without disturbing noise, without harm to the environment and constant expenses for fuel and maintenance!



- ✓ Home/outdoors backup power
- ✓ Solar panel charging support
- ✓ High capacity LifePO4 battery

- ✓ LCD light panel
- ✓ Smart & safe
- ✓ Energy storage function

KS 300PS	
Rated\Peak power	300 W / 500 W (20 mc)
Cell capacity	23 Ah / 294 Wh, 3.2 V
0 to 100% charging with adapter via DC7909	100 W Adapter 20 V / 5 A
Charging with MPPT PV module	DC 7909 120 W max
AC socket	230 V / 50 Hz
USB-A port QC 3.0	2×18 W
Type-C port	PD 100 W
Car cigarette lighter	12 V / 10 A
Net dimensions (LxWxH)	340×105×185 mm
Net Weight	4.3 kg



PURE SINE WAVE



KS 500PS	
Rated\Peak power	500 W/1000 W (20 mc)
Cell capacity	35 Ah/448 Wh, 3.2 V
0 to 100% charging with adapter via DC7909	100 W Adapter 20 V/5 A
Charging with MPPT PV module	DC 7909 120W max
AC socket	230 V/50 Hz
USB-A port QC 3.0	2×18 W
Type-C port	PD 100 W
Car cigarette lighter	12 V/10 A
Net dimensions (LxWxH)	340×105×185 mm
Net Weight	4.9 kg



PURE SINE WAVE



KS 1200PS	
Rated\Peak power	1200 W /2400 W (20 mc)
Cell capacity	23 Ah / 1030 Wh, 3.2 V
0 to 100% charging with adapter via DC7909	1000 Wh (~ 2 hours)
Charging with MPPT PV module	XT60 max 800 W
XT60 charging	12-59 V max 800 W
AC socket	2×230 V / 50 Hz
USB-A port QC 3.0	2×18 W
Type-C1 port/Type-C2 port	PD 100 W / PD 100 W
Car cigarette lighter	12 V / 10 A
Net dimensions (LxWxH)	340×220×254 mm
Net Weight	12.4 kg

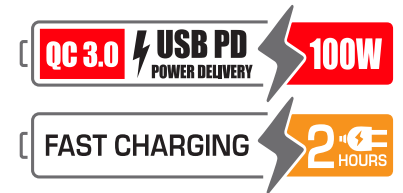

PURE SINE WAVE



KS 2400PS	
Rated\Peak power	2400 W / 4800 W (20 mc)
Cell capacity	50 Ah / 2240 Wh, 3.2 V
0 to 100% charging with adapter via DC7909	2000 Wh (~ 2 hours)
Charging with MPPT PV module	XT60 max 2×500 W
XT60 charging	2×12-59 V max 500 W
AC socket	4×230 V/50 Hz
USB-A port QC 3.0	2×18 W
Type-C1 port/Type-C2 port	PD 100 W / PD 100 W
Car cigarette lighter	12 V / 10 A
Net dimensions (LxWxH)	409×299×307 mm
Net Weight	25.9 kg

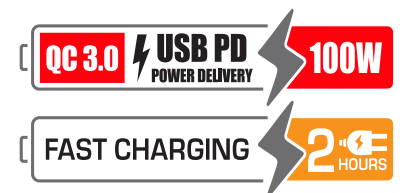

PURE SINE WAVE



PORTABLE POWER STATIONS

EXTRA BATTERY FOR POWER STATION

KS EXB-2400	
Rated power	2400 W
Cell capacity	2240 Wh 50 Ah /44.8 V
Net dimensions (LxWxH)	409x299x192 mm
Net Weight	19.7 kg



LiFePO₄ BATTERY

LiFePO₄ batteries are safer than Li-ion equivalents, as they are less prone to overheating and combustion. Additionally, LiFePO₄ batteries are more resistant to extreme temperatures and can operate in a wider temperature range compared to some Li-ion batteries.



PORTABLE SOLAR PANELS



120 – 210 W

Könner & Söhnen® **portable solar panels** are lightweight and compact devices that use renewable energy from sunlight. With them at hand, you can conveniently travel around and charge your devices for free multiple times.

The high-quality monocrystalline solar cells provide high efficiency of conversion of solar energy into electric energy (up to 23%) and long service life.

The environmentally friendly, practical and handy solar panel is suitable for outdoor activities, emergencies and working outdoors. It provides uninterrupted power even on cloudy days.

It does not harm the environment during operation.

✓ HIGH-QUALITY MONOCRYSTALLINE ELEMENTS

Modern monocrystalline silicon has the energy conversion efficiency of about 20%. Energy generation is possible even in a cloudy day and with partial layout.

✓ USER-FRIENDLY

Foldable design with portable size, easy to carry with just a single hand. The ability to operate in a partially unfolded state enables the portable solar panel to be used in confined spaces or on the move. Panels feature additional stands for vertical deployment to maximize sun rays interception.

✓ FOLDABLE DESIGN, COMPACT DIMENSIONS

Foldable design with compact dimensions, convenient for one-handed transport.

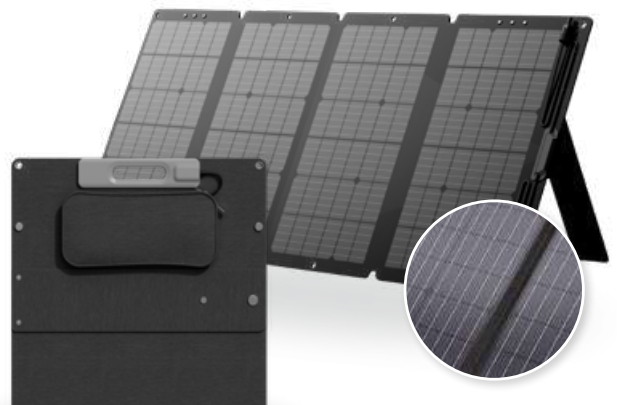

KS SP120W-4	
Rated Solar Power	120 W
Interface	MC4/DC7909
Voltage	20.8 V
Supply Current	5.76 A
Working temperature	-10 °C ~ 65 °C
Conversion efficiency	≤ 21-22%
Suitable for models	KS 300PS, KS 500PS
Cable length	200 cm
Folded size (LxWxH)	616×381×25 mm
Unfold size (LxWxH)	1370×616×15 mm
Weight	6 kg

ALSO INCLUDED IN THE SET:

- 1×120 W solar panel
- 1×MC4 to DC7909



KS SP210W-4	
Rated Solar Power	210 W
Interface	MC4/DC7909
Voltage	23.14 V
Supply Current	11.16 A
Working temperature	-10 °C ~ 65 °C
Conversion efficiency	≤ 21-22%
Suitable for models	KS 300PS, KS 500PS, KS 1200PS, KS 2400PS
Cable length	200 cm
Folded size (LxWxH), mm	681×555×45 mm
Unfold size (LxWxH), mm	2075×681×25 mm
Weight	8.12 kg

ALSO INCLUDED IN THE SET:

- 1×210 W solar panel
- 1×MC4 to XT60



PORTABLE SOLAR PANELS

Using solar panels along with portable power stations, you can convert free solar energy into direct current, store it during the day in portable power stations, and use it at night.

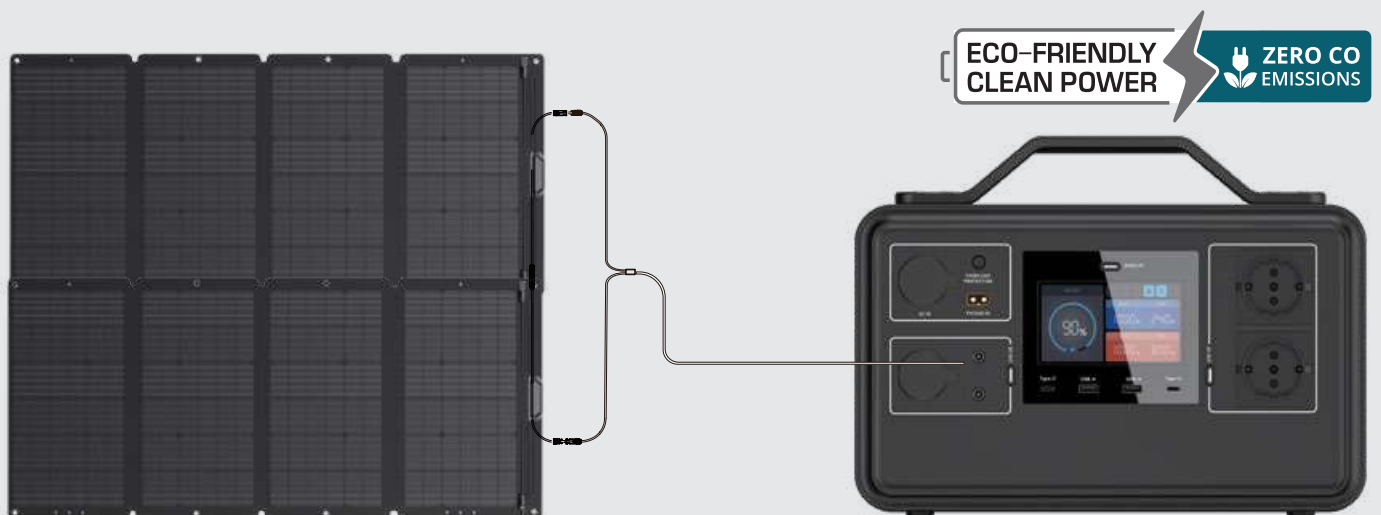



PORTABLE POWER STATIONS

 **2000 – 3000 W**



The new powerful portable charging stations from Könnert & Söhnen® are an innovative solution characterized by reliability, mobility, cost-efficient benefits, and ecological safety. These modern multifunctional devices combine a rechargeable battery, a solar inverter with the ability to connect solar panels, and an uninterruptible power supply system with a pure sine wave.

One of the main problems today is the possibility of unexpected power outages. In the modern world, being without electricity means not only being without lighting, water, and heating but also being without information and communication with loved ones, significantly increasing the stress level in these challenging times for the entire world. Könnert & Söhnen® **charging stations** are the ideal solution for the safety and peace of your family in case of unexpected circumstances.

Rated power



2000 – 3000 W

Battery capacity



1792 – 3225 Wh

Cycle times



≤ 6000 TIMES

Pure sine wave

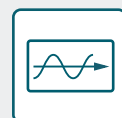

**SUITABLE FOR
SENSITIVE DEVICES**

✓ **LiFePO4**

Our charging stations, based on high-quality lithium-iron-phosphate batteries, provide amazing 6000+ recharge cycles – their service life is twice as long compared to lithium-ion batteries. Moreover, they have large capacity and higher energy density while being thin and lightweight at the same time.

✓ **Pure sine wave**

The integrated inverter generates a „pure sine wave“ which is well-suited for microprocessor technology and all devices with sensitive electronics.

These stations are suitable for homes, apartments, and business premises, workshops, camping, and various events. They can power most of your devices, from smartphones and laptops to coffee makers, refrigerators, and other equipment in case of unexpected power outages or during travels and outdoor activities. They have high efficiency and low losses under static load, as well as high performance and power density, which is crucial for a mobile system.

✔ HYBRID FUNCTIONALITY AND COMPATIBILITY WITH A GENERATOR

Can accumulate energy in three different ways: from the alternating current network, solar panels, and a generator. Enables setting the charging source priority. Supports an auxiliary power source – the ability to connect an inverter generator.

✔ SILENT AND MOBILE

These devices produce minimal external noise during operation, enabling you to use the device in close proximity while enjoying a normal lifestyle. This is an ideal solution for those who value peace and quiet. Equipped with wheels and handles for easy transportation.

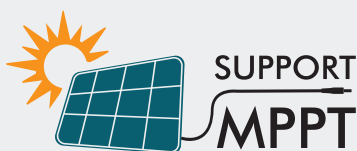

Maximum Power Point Tracking (MPPT) - is an intelligent management system that continuously monitors and finds the maximum power point in your solar system. This means that even with changes in lighting and temperature, you will get the maximum energy from each solar cell.



We value the environment and strive to minimize the impact of our products on the surroundings. Therefore, we implement cutting-edge technologies that enable us to reduce the harmful impact on the environment.

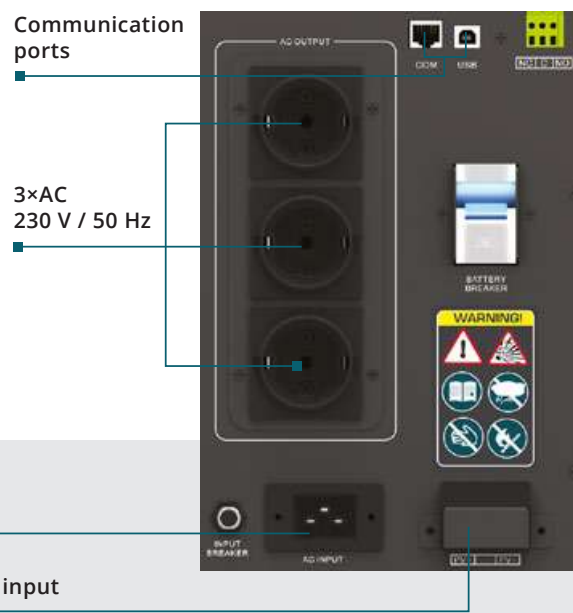

POWERFUL PORTABLE POWER STATIONS



POWERFUL PORTABLE POWER STATIONS

ADVANTAGES OF PORTABLE POWER STATIONS FROM KÖNNER & SÖHNEN®

✓ ECO-FRIENDLY

Eco-friendly energy sources that do not produce harmful waste during use and do not impact the environment or climate in the region.

✓ COEFFICIENT OF EFFICIENCY

The CED (coefficient of useful power) of the portable power station is 90%, indicating high efficiency.

✓ COST SAVINGS

You can collect free solar energy by connecting solar panels to the charging stations, significantly reducing your electricity costs. Additionally, you can save money by storing electricity from the central grid at night during lower tariff periods and using it during the day.

✓ USER-FRIENDLY

Require no complex technical maintenance: refueling, oil changes, filter replacements.



Powerful portable power stations Könnert & Söhnen® can accumulate energy through three different methods: from the alternating current grid, solar panels, and a generator. It enables for setting the charging source priority.

✓ LCD DISPLAY

The control panel features an LCD display that shows key operational indicators and programming settings. It displays battery charge levels (0-24%, 25-49%, 50-74%, and 75-100%), as well as input voltage, input frequency, solar panel voltage, battery voltage, and charging current. It also indicates output voltage, frequency, load in VA, load in watts, and battery discharge current.

✓ MULTIPOINT

They have 10 outputs for connecting various devices simultaneously. Different types of connectors enable the use of a multitude of electrical appliances.



By purchasing the Könnert & Söhnen® portable power station, you not only get a comfortable life with an eco-friendly energy source but also significant cost savings.

KS 2000PS	
Rated Power	2000 W
Capacity	70 Ah/1792 Wh, 25.6 V
PV INPUT	
Maximum current	60 A
Maximum idle voltage from solar panels	145 V (DC)
MPPT voltage range from solar panels	30~120 V (DC)
AC INPUT	
Rated Input Voltage	230 V ± 5% (AC)
AC Charge Current	20 A (±4 A)
USB Output	4 x USB Type A (5 V), 1 x USB Type C
AC Output	3 x Schuko 230 V
DC Output	2 x DC 12 V
Gross dimensions (LxWxH)	450×370×320 mm
Gross weight	30 kg

ECO-FRIENDLY CLEAN POWER ZERO CO EMISSIONS

PURE SINE WAVE



MULTI-LEVEL PROTECTION AGAINST:

- Overcurrent
- Overcharging
- Excessive discharge
- Overheating
- Short circuit

KS 3000PS	
Rated Power	3000 W
Capacity	126 Ah/3225 Wh, 25.6 V
PV INPUT	
Maximum current	60 A
Maximum idle voltage from solar panels	145 V (DC)
MPPT voltage range from solar panels	30~120 V (DC)
AC INPUT	
Rated Input Voltage	230 V ± 5% (AC)
AC Charge Current	30 A (±4 A)
USB Output	4 x USB Type A (5 V), 1 x Type C (5 V)
AC Output	3 x Schuko 230 V
DC Output	2 x DC 12 V
Gross dimensions (LxWxH)	570×370×445 mm
Gross weight	36 kg

ECO-FRIENDLY CLEAN POWER ZERO CO EMISSIONS

PURE SINE WAVE



MULTI-LEVEL PROTECTION AGAINST:

- Overcurrent
- Overcharging
- Excessive discharge
- Overheating
- Short circuit

POWERFUL PORTABLE POWER STATIONS



PORTABLE POWER STATIONS

PORTABLE POWER STATION



KS 300PS



KS 500PS



KS 1200PS



KS 2400PS

BATTERY				
Capacity	294 Wh	448 Wh	1030 Wh	2240 Wh
Cell type	Lithium Iron Phosphate LifePO4 Batteries			
Cell capacity	23 Ah	35 Ah	23 Ah	50 Ah
Cell Qty	4 pcs.	4 pcs.	14 pcs.	14 pcs.
Single cell voltage	3.2 V	3.2 V	3.2 V	3.2 V
Lifecycle	4000 cycles \geq 80% of the time			
AC OUTPUT				
AC socket	230 V / 50 Hz		2x230 V / 50 Hz	4x230 V / 50 Hz
Rated power	300 W	500 W	1200 W	2400 W
Peak power	500 W (20 mc)	500 W (20 mc)	1200 W (20 mc)	2400 W (20 mc)
Conversion efficiency	\geq 92%	\geq 92%	\geq 92%	\geq 92%
DC OUTPUT				
Type-C port	Type-C1: PD100 W		Type-C1: PD 100 W, Type-C2: PD 45 W	
USB-A port	12.0 / 8.83	14.0 / 10.3	14.0 / 10.3	18.0 / 13.24
Car cigarette lighter	12 V / 10 A	12 V / 10 A	12 V / 10 A	12 V / 10 A
DC-5525 port	12 V / 10 A	12 V / 10 A	2x12 V / 10 A	2x12 V / 10 A
INPUT				
0 to 100% charging with adapter via DC7909	100 W Adapter 20 V / 5 A	100 W Adapter 20 V / 5 A	-	-
0 to 100% charging from AC outlet	-	-	1000Wh around 2 h full charge	2000Wh around 2 h full charge
Charging with MPPT PV module	DC 7909, max 120 W	DC 7909, max 120 W	XT60 max 800 W	XT60 max 800 W
XT60 charging	-	-	12-59 V maks 800 W	2x12-59 V maks 500 W
Extra battery port	-	-	-	2 pcs.
LED Flashlight	+	+	-	-
Bluetooth	Bluetooth 5.0			
Application management	+	+	+	+
Net dimensions (LxWxH)	340x105x185 mm	340x105x185 mm	340x220x254 mm	409x299x307 mm
Weight	4.3 kg	4.9 kg	12.4 kg	25.9 kg
Storage Temp	-10 °C + 45 °C			
Working Temp	-10 °C + 40 °C			
Charging Temp	-10 °C + 40 °C			



Powerful models of portable chargers (KS 1200PS and KS 2400PS) come with a LiFePO4 battery fast-charging device that charges the station quickly and safely. In just 2 hours, the battery reserve will be replenished, and the station will be ready for operation.



Portable power stations Könnert & Söhner® are equipped with Power Delivery technology, which ensures fast charging batteries of modern smartphones and even laptops.



We value the environment and strive to minimize the impact of our products on the surroundings. Therefore, we implement cutting-edge technologies that allow us to reduce the harmful impact on the environment.



KS 2000PS



KS 3000PS

**EFFECTIVE PORTABLE
POWER STATIONS**

INVERTER		
Rated Power	2000 W	3000 W
The shape of the output	Pure Sine Wave	
AC Voltage Output	230 V	230 V
Nominal battery voltage	25.6 V (DC)	25.6 V (DC)
Efficiency	90%	90%
PV INPUT		
Maximum current	60 A	60 A
Efficiency of the MPP converter	98% max	98% max
Maximum idle voltage from solar panels	145 V (DC)	145 V (DC)
MPPT voltage range from solar panels	30~120 V (DC)	30~120 V (DC)
AC INPUT		
Rated Input Voltage	230 V ± 5% (AC)	230 V ± 5% (AC)
Input Voltage Range	90-280 V (AC)	90-280 V (AC)
Frequency Range	50 Hz	50 Hz
Transfer Time	10 mc (UPS, VDE); 20 mc (APL)	10 mc (UPS, VDE); 20 mc (APL)
AC Charge Current	20 A (±4 A)	30 A (±4 A)
BUILT-IN BATTERY		
Battery Type	Lithium Iron Phosphate LifePO4 Batteries	
Capacity	70 Ah/1792 Wh	126 Ah/3225 Wh
Rated Voltage	25.6 V (DC)	25.6 V (DC)
DC Output	+	+
USB Output	+	+
Gross dimensions (LxWxH)	450x370x320 mm	570x370x445 mm
Gross weight	32 kg	38 kg
Net weight	30 kg	36 kg

PORTABLE POWER STATIONS



LiFePO4 batteries are safer than Li-ion batteries, being less prone to overheating and combustion. Additionally, LiFePO4 batteries demonstrate greater resilience to extreme temperatures and can operate within a wider temperature range compared to some Li-ion equivalents. Utilizing renewable energy sources contributes to environmental conservation.



GASOLINE GENERATORS

 2.5 kW–15.6 kVA



Dimax International GmbH (Germany) has the honor to introduce gasoline generators from Könnér & Söhnen®, which have already established themselves as reliable equipment at an affordable price and have become much-in-demand in many countries worldwide.

Our assortment features a wide model range of gasoline generators with unique functionality to maximize customer satisfaction.

The motto of Könnér & Söhnen® is TRADITIONS OF GERMAN QUALITY, and we are proud to responsibly follow it.



Gasoline generators from Könnert & Söhnen® are modern, high-quality equipment that is used in multiple areas as a reliable backup power source.

Our assortment features a wide model range of gasoline generators with unique functionality to maximize customer satisfaction. The range of gasoline generators comprises 2,5 kW – 15,6 kVA models with manual, electric and automatic start for single-and three-phase appliances, equipped with a multifunctional LED-display, automatic circuit breakers for overload and low oil level.

Könnert & Söhnen® generators meets the highest international quality standards, including the latest Euro 5 emission standard.

Generator power



2,6 kW–15,6 kVA

Voltage



230V/400V

Engine start



MANUAL/ELECTRIC

Engine power



6,5–18 HP



GASOLINE GENERATORS



Powerful and reliable EURO 5 engine of Könnert & Söhnen®



3D REVIEW



REVIEW VIDEO OF GENERATOR IN WORK





GASOLINE GENERATORS

Thanks to the introduction of cutting-edge technologies and innovative solutions, Könnert & Söhnen® equipment meets the highest international quality standards, including the latest Euro 5 emission standard.



RELIABLE BRANDED ENGINES

Könnert & Söhnen® engines are reliable, high-performance and cost-effective, and conform to European quality standards. Each engine has a corporate K&S stamp and an individual serial number in order to ensure the quality control of manufacture and after-sales service.



ALTERNATOR WITH 100% COPPER WINDING

Könnert & Söhnen® generators are equipped with a high-end synchronous alternator with 100% copper winding. It is only the copper winding that can withstand maximum loads without any damage to ensure long-term reliable operation of the generator set. **In models KS 2900, KS 2900G, KS 5000E G alternator with aluminum winding.*



USER-FRIENDLY ERGONOMIC CONTROL PANEL

The ergonomic generator control panel allows easy operation thanks to the convenient location of all functions: modern LEDdisplay (hour meter, frequency, voltage), electric start (optional), overload circuit breaker, low oil level sensor, sockets, grounding connector, terminals, etc.



DOUBLE ANTI-VIBRATION SYSTEM

Könnert & Söhnen® generators are equipped with a double antivibration system to ensure noise reduction and extend the service life of the generator. Engines are mounted on top-notch rubber bearings. The reinforced steel frame has additional rubber mounts for protection against sliding, corrosion, and vibration.

KS 2900



Max power	2,9 kW
Nominal power	2,5 kW
Voltage	230 V
Engine start	manual
Outlets	2x16A
Net dimensions (LxWxH)	580x430x440 mm
Net weight	41,5 kg



KS 3000



Max power	3,0 kW
Nominal power	2,6 kW
Voltage	230 V
Engine start	manual
Outlets	2x16A
Net dimensions (LxWxH)	580x430x440 mm
Net weight	41,5 kg



KS 3000E



Max power	3,0 kW
Nominal power	2,6 kW
Voltage	230 V
Engine start	manual/electric
Outlets	2x16A
Net dimensions (LxWxH)	580x430x440 mm
Net weight	46,1 kg



KS 7000



Max power	5,5 kW
Nominal power	5,0 kW
Voltage	230 V
Engine start	manual
Outlets	1x16A, 1x32A
Net dimensions (LxWxH)	680x545x550 mm
Net weight	69,2 kg





GASOLINE GENERATORS

FOR CONSTRUCTION



A construction site is a place where power tools are used all the time.

Könner & Söhnen® generators are especially useful for construction work on off-grid sites, on sites where power lines are not powerful enough, or there are no power outlets at all, or where a sudden power outage must not bring the construction work to a halt.

*KS 10000E series models (single-phase) have the possibility of welding inverter connection with maximum current up to 200 A, only in case that the welding inverter has 85% efficiency and an arc voltage of 25 V.

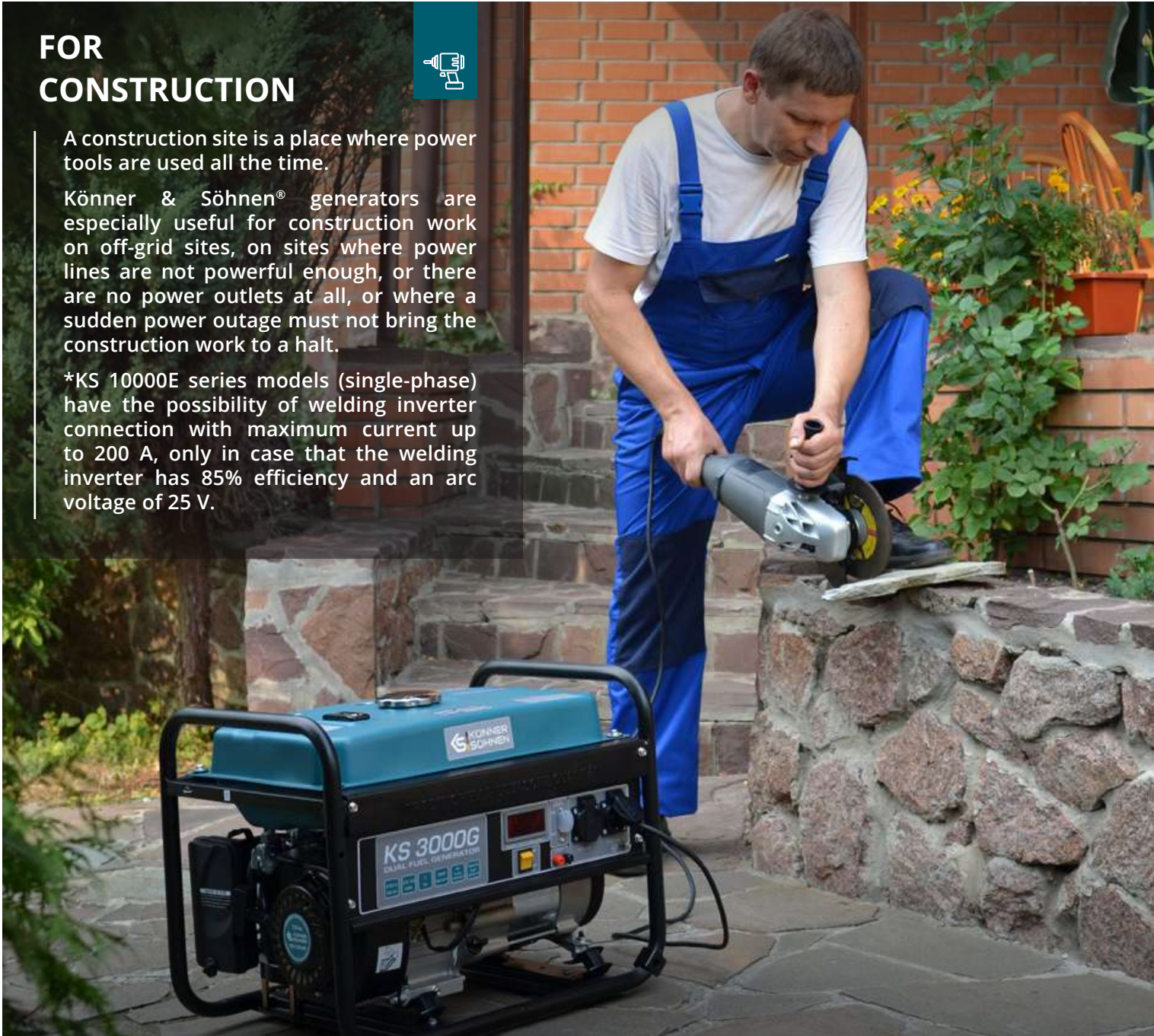

KS 7000E



Max power	5,5 kW
Nominal power	5,0 kW
Voltage	230 V
Engine start	manual/electric
Outlets	1x16A, 1x32A
Net dimensions (LxWxH)	680x545x550 mm
Net weight	76,2 kg



KS 7000E-3



Max power	5,5 kW
Nominal power	5,0 kW
Voltage	400 V
Engine start	manual/electric
Outlets	1x16A (230 V), 1x16A (400 V)
Net dimensions (LxWxH)	680x545x550 mm
Net weight	80,8 kg



KS 10000E



Max power	8,0 kW
Nominal power	7,5 kW
Voltage	230 V
Engine start	manual/electric
Outlets	1x16A, 1x32A
Net dimensions (LxWxH)	680x545x550 mm
Net weight	85,5 kg



KS 10000E-3



Max power	8,0 kW
Nominal power	7,5 kW
Voltage	400 V
Engine start	manual/electric
Outlets	1x16A (230 V), 1x16A (400 V)
Net dimensions (LxWxH)	680x545x550 mm
Net weight	88 kg





GASOLINE GENERATORS WITH ATS SYSTEM

One of the unique features of our generators is a **built-in ATS** (automatic transfer switch) system. This system allows generator to monitor central power availability and to automatically switch itself on when the electricity is turned off and then automatically switch off when the power is available again. The function becomes irreplaceable and extremely convenient in buildings with severe temperature or light conditions in the absence of personnel control.

It does not require any additional sophisticated equipment to run automatic reserve entry. ATS unit is already built into the generator, installation is as simple as possible and the cost of these models is highly affordable.

“GREEN” ENERGY COMPATIBILITY

Integration with “green” energy (solar, wind power plants) - generators with built-in ATS system can be connected to the solar inverter controller to start automatic battery charging and providing electricity supply to the house.

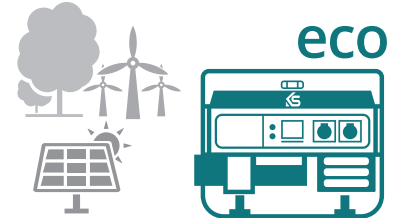

Generator power



5,0 kW–8,0 kW

Voltage



230V/400V

Engine start



MANUAL/ELECTRIC/AUTO

Engine power



13–18 HP



LED-display: voltage, frequency, working hours

ATS switch
ATS operation indicator

Circuit breaker. Overload and short circuit protection

External power supply connectors



Powerful and reliable EURO 5 engine of Könnér & Söhnen®



3D REVIEW



REVIEW VIDEO OF GENERATOR IN WORK





BUILT-IN ATS SYSTEM

The generator control panel with the ATS function (automatic transfer switch) is equipped with power terminals, ATS switch and ATS operation indicator.



SWITCHING CONTACTORS

Reliable 100% copper switching contactors have an increased capacity of 40 A, which ensures long-term fail-safe performance of the ATS system.



230 V OR 400 V

The presented series includes models for single- and three-phase consumers. The generator control panel with the ATS function has corresponding 230V and 400V mains terminals.



LED DISPLAY

The display shows information about frequency, voltage and operating hours of the generator in order to ensure timely maintenance of the generator and extend its service life.

GASOLINE GENERATORS



GASOLINE GENERATORS WITH ATS SYSTEM



FOR HOME

Occasional power outages can interfere with the comfort of country life.

Könnér & Söhnen® gasoline generators are the ideal backup power source for private homes that guarantee your usual daily routine in an emergency. With a Könnér & Söhnen® generator, every family gets reliable protection and can enjoy everyday life and use critical appliances during power outages.

These high-performance units exhibit consistent performance and can power various single-phase and three-phase household appliances. They are more space-efficient and easy to maintain than diesel generators.



KS 7000E ATS



Max power	5,5 kW
Nominal power	5,0 kW
Voltage	230 V
Engine start	manual/electric/auto
Outlets	1x16A, 1x32A
Net dimensions (LxWxH)	680x545x550 mm
Net weight	76,8 kg



KS 7000E-3 ATS



Max power	5,5 kW
Nominal power	5,0 kW
Voltage	400 V
Engine start	manual/electric/auto
Outlets	1x16A (230 V), 1x16A (400 V)
Net dimensions (LxWxH)	680x545x550 mm
Net weight	82,3 kg



KS 10000E ATS



Max power	8,0 kW
Nominal power	7,5 kW
Voltage	230 V
Engine start	manual/electric/auto
Outlets	1x16A, 1x32A
Net dimensions (LxWxH)	680x545x550 mm
Net weight	87,8 kg



KS 10000E-3 ATS



Max power	8,0 kW
Nominal power	7,5 kW
Voltage	400 V
Engine start	manual/electric/auto
Outlets	1x16A (230 V), 1x16A (400 V)
Net dimensions (LxWxH)	680x545x550 mm
Net weight	89,2 kg



*KS 10000E series models (single-phase) have the possibility of welding inverter connection with maximum current up to 200 A, only in case that the welding inverter has 85% efficiency and an arc voltage of 25 V.

** Generator can be connected to the solar charge controller.



Universal high-performance generators 2 in 1 from Könnert & Söhnen®!

There is no need to purchase two separate generators for single- and three-phase consumers since Könnert & Söhnen® generators with a unique innovative VTS (Voltage Transfer Switch) phase switching system provide equal power for single-phase (230V) and three-phase (400V) appliances thanks to innovative technology.

It is no longer necessary even to stop the generator engine: just switch to the required mode, enable the appropriate circuit breakers (ON) and connect the appliances.

Generator power



5,0 kW–8,0 kW

Voltage



230V/400V

Engine start



MANUAL/ELECTRIC

Engine power



13–18 HP

- ✓ Equal power for single-phase (230V) and three-phase (400V) - unique innovative VTS system
- ✓ High-performance gasoline engines from Könnert & Söhnen® conform to latest standard of emission EURO 5.

- ✓ Alternator specially designed for single- and three-phase operation without loss of power
- ✓ Automatic overload and short circuit protection

Circuit breaker.
Overload and short circuit
protection for each mode 230V / 400V

LED-display: voltage,
frequency, working hours

VTS phase switching system

Outlets for single-phase
and three-phase consumers



Powerful and reliable EURO 5
engine of Könnert & Söhnen®

Specially designed alternator
for single-phase and three-phase
operation modes. 100% copper winding



3D REVIEW



REVIEW VIDEO
OF GENERATOR
IN WORK





VTS SYSTEM

The unique innovative VTS (voltage Transfer Switch) phase switching system with equal power for single-phase (230V) and three-phase (400V) consumers. Each mode has its own circuit breaker.



SYNCHRONOUS ALTERNATOR

The synchronous alternator with integrated intelligent AVR system is specially designed for single- and three-phase operation without loss of power. High workmanship and copper winding can withstand prolonged ultimate loads.



HIGH-PERFORMANCE ENGINE

Each Könnér & Söhnen® engine is equipped with a backup power supply, which ensures Könnér & Söhnen® generators deliver the declared power for sure! K&S engines conform to European quality standards, including the latest standard of emission EURO 5.



EQUIPMENT

The generator panel is equipped with ergonomic connectors for connecting single- and three-phase consumers. High-output sockets are made of high-quality heat-resistant plastic.

GASOLINE GENERATORS



GASOLINE GENERATORS WITH VTS SYSTEM



KS 7000E-1/3

Max power/Nom. power, 230 V	5,5/5,0 kW
Max power/Nom. power, 400 V	5,5/5,0 kW
Voltage	230 V/400 V
Engine start	manual/electric
Outlets	1x16A (400 V) 1x32A (230 V)
Net dimensions (LxWxH)	680x545x550 mm
Net weight	81 kg



KS 10000E-1/3

Max power/Nom. power, 230 V	8,0/7,5 kW
Max power/Nom. power, 400 V	8,0/7,5 kW
Voltage	230 V/400 V
Engine start	manual/electric
Outlets	1x16A (400 V) 1x32A (230 V)
Net dimensions (LxWxH)	680x545x550 mm
Net weight	88 kg



KS 10000E series models (single-phase) have the possibility of welding inverter connection with maximum current up to 200 A, only in case that the welding inverter has 85% efficiency and an arc voltage of 25 V.

Voltage transfer switch system

7.5 kW 230V = 7.5 kW 400V

Allows using the generator both in three-phase mode (400V) and in single-phase mode (230V) without loss of power

The unique innovative phase switching system allows using the generator both in three-phase (400V) and in single-phase mode (230V). It is no longer necessary to purchase two separate generators and maintain them: just switch the mode and use the Könnér & Söhnen® generator with the phase switching system at the required voltage.



GASOLINE GENERATORS



LPG/GASOLINE GENERATORS

DUAL FUEL series LPG/gasoline generators from Könnér & Söhnen® can run on both gasoline and liquefied gas (propane-butane). The package includes everything you need to use LPG as fuel.



DUAL FUEL series LPG/gasoline generators from Könnér & Söhnen® are currently the most popular among customers due to their efficiency. The generator can run on both gasoline and liquefied gas (propane-butane).

The operation of the generator on LPG increases the service life of the engine. The package includes everything you need to use LPG as fuel: built-in reducer that provides gas supply during engine operation, prevents gas leakage, as well as terminates gas supply when the generator is off; 1.5 m long hose for connecting a gas cylinder provides a convenient connection; the hose is equipped with an additional reducer that is mounted on the cylinder to increase the reliability of the gas line.

Just connect the generator to the cylinder and start the engine. If necessary, LPG/gasoline models can easily be switched to gasoline mode.

✔ There is no need to add gasoline to the fuel tank to start the generator. The generator can start and run directly on LPG.

✔ The most simple connection - you need just connect the hose to your cylinder.

The reducer provides pressure reduction and eliminates the possibility of gas connection overloading (standard DIN 477)

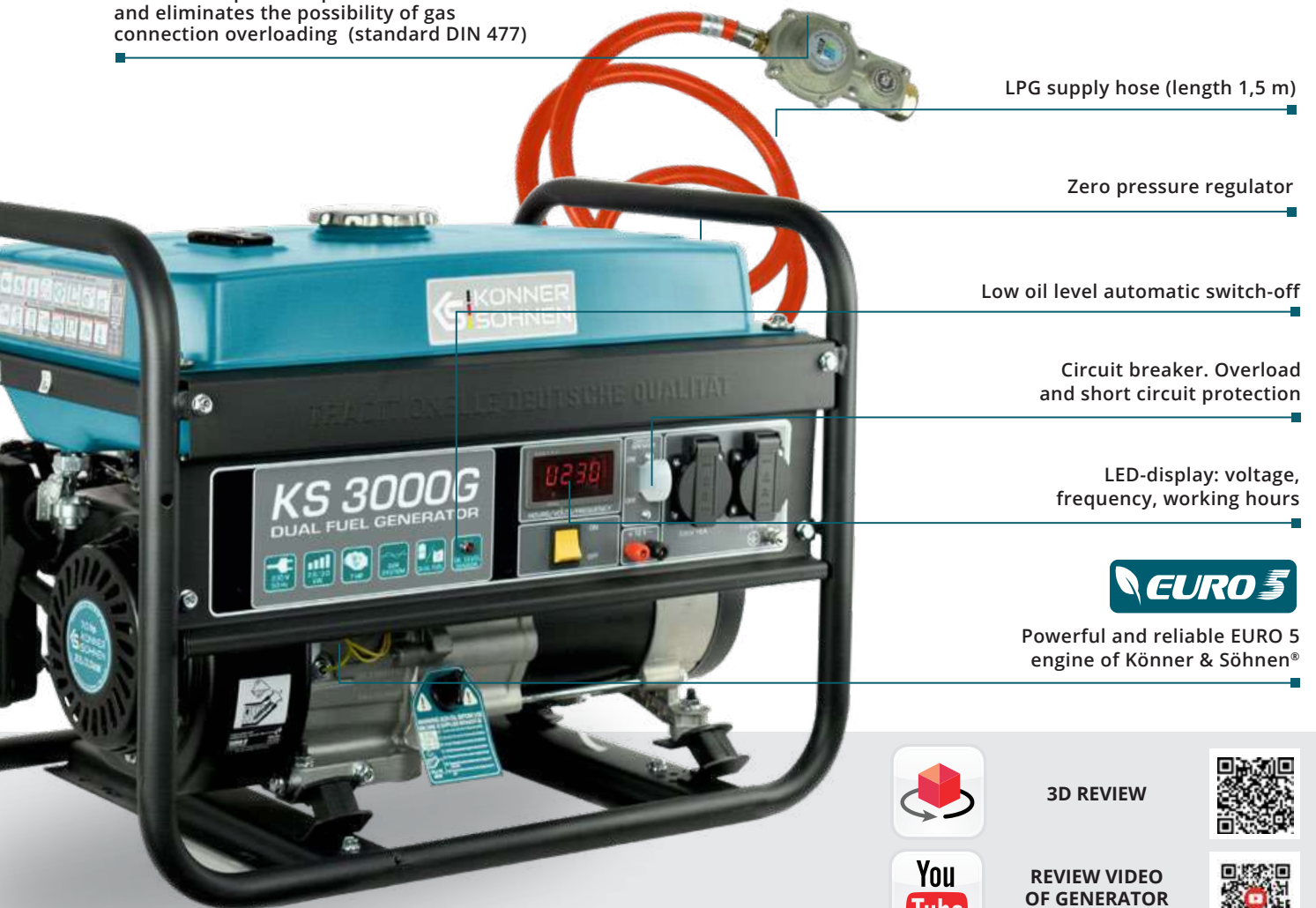

LPG supply hose (length 1,5 m)

Zero pressure regulator

Low oil level automatic switch-off

Circuit breaker. Overload and short circuit protection

LED-display: voltage, frequency, working hours



Powerful and reliable EURO 5 engine of Könnér & Söhnen®

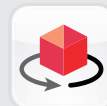

3D REVIEW



REVIEW VIDEO OF GENERATOR IN WORK





ECONOMICAL CHOICE

Apart from connection to a regular portable gas cylinder, Könnér & Söhnen® LPG/gasoline generators can be connected to an existing 30-50 mBar LPG (propane, butane) distribution system (connection hose is not included). LPG/gasoline models can easily be switched to gasoline operation.



EQUIPMENT

The package includes everything necessary for using LPG as fuel, specifically zero pressure regulator, the hose for connecting to your gas cylinder, reducer that is mounted on the cylinder. All you need is to connect the generator to the cylinder and start the engine.



ENVIRONMENTALLY - FRIENDLY ENGINE

LPG is a more environmentally friendly fuel than gasoline. The use of LPG as fuel provides less emissions of harmful exhaust substances into the atmosphere.



IMPROVED ENGINE EFFICIENCY

When operated on liquefied gas, the engine provides less vibration in a way that facilitates long and stable generator operation and increases engine service life.

GASOLINE GENERATORS



LPG/GASOLINE GENERATORS

KS 2900G



Max power	2,9 kW
Nominal power	2,5 kW
Voltage	230 V
Engine start	manual
Outlets	2x16A
Net dimensions (LxWxH)	580x430x440 mm
Net weight	43 kg



KS 3000G



Max power	3,0 kW
Nominal power	2,6 kW
Voltage	230 V
Engine start	manual
Outlets	2x16A
Net dimensions (LxWxH)	580x430x440 mm
Net weight	45.4 kg



KS 5000E G



Max power	4,5 kW
Nominal power	4,0 kW
Voltage	230 V
Engine start	manual/electric
Outlets	2x16A
Net dimensions (LxWxH)	680x545x550 mm
Net weight	77 kg



KS 7000E G



Max power	5,5 kW
Nominal power	5,0 kW
Voltage	230 V
Engine start	manual/electric
Outlets	1x16A, 1x32A
Net dimensions (LxWxH)	680x545x550 mm
Net weight	77,2 kg



KS 9000E G



Max power	6,5 kW
Nominal power	6,0 kW
Voltage	230 V
Engine start	manual/electric
Outlets	1x16A, 1x32A
Net dimensions (LxWxH)	680x545x550 mm
Net weight	83 kg



KS 10000E G



Max power	8,0 kW
Nominal power	7,5 kW
Voltage	230 V
Engine start	manual/electric
Outlets	1x16A, 1x32A
Net dimensions (LxWxH)	680x545x550 mm
Net weight	86,5 kg



Liquefied gas (propane-butane) is more environmentally friendly than gasoline. The use of gas as fuel reduces the amount of harmful emissions into the atmosphere.



GASOLINE GENERATORS



GASOLINE 1- AND 2-CYLINDER GENERATORS

Generators for your attention - powerful gasoline **single and two-cylinder models** with 8,0 kW to 15,6 kVA power with the possibility of ATS unit connection. KS 12-1E 1/3 ATSR and KS 15-1E 1/3 ATSR generators also have a unique VTS phase switching technology that enables single-phase (230V) or three-phase (400V) operation with almost no power loss.

Generators are based on robust single- and two-cylinder engines that meet the latest EURO 5 emission standard. Generators are also equipped with convenient, ergonomic control panel with emergency stop button and multi-function LED display to control generator operation - frequency, voltage, hours worked and low oil level. Each model is equipped with outlets to allow you to get maximum power delivered by the device. The capacious 55-liter fuel tank ensures long and continuous operation. Generators have a reinforced ø32 mm steel frame, equipped with a transport kit to ease transportation. Anti-corrosion electrostatic painting protects the device from mechanical damage and environmental influences.

Generator power



8,0 kW-15,6 kVA

Voltage



230V/400V

Engine start



MANUAL/ELECTRIC

Engine power



18,5-22 HP



Engine emergency shutdown

LED-display: voltage, frequency, working hours, oil alarm

VTS phase switching system for models KS 12-1E 1/3 ATSR, KS 15-1E 1/3 ATSR

8-pin ATS input



Reliable 1- or 2-cylinder engines Köhner & Söhne®

8.0 kW - 15.6 kVA
POWERFUL GASOLINE GENERATORS
BASED ON TWO-CYLINDER ENGINES





POWERFUL ENGINE

Powerful and reliable 1-, or 2-cylinder engines with air cooling (18.5 - 22 hp) comply with all international and European standards of quality, including latest emission standard EURO 5. Each engine has an individual serial number for control the quality of production and service.



SYSTEM VTS

Universal generators 2 in 1 have a unique VTS (Voltage Transfer Switch) phase switching system, which allows using a single generator both in single-phase mode (230V) and in three-phase mode (400V) with almost no loss of power. The models are equipped with single-phase and three-phase outlets, which enable the maximum power output of the unit. The generators feature circuit breakers for each operating mode.



ERGONOMIC CONTROL PANEL

The user-friendly ergonomic control panel allows easy control of the whole device, requires no special skills; modern LED- display (hour meter, frequency, voltage, oil alarm); overload and short circuit protection; ATS input. Panel is equipped with engine emergency switch.



ATS OUTPUT

The generator is suitable for connecting the ATS (automatic transfer switch) system. The ATS input features a 8-pin connector. The ATS unit automatically starts the generator and transfers load to it when the main power supply is disconnected and automatically stops the generator when the central power supply is restored.

GASOLINE GENERATORS



GASOLINE 1- AND 2-CYLINDER GENERATORS

KS 12-1E ATSR



Max power	9,2 kW
Nominal power	9,0 kW
Voltage	230 V
Engine start	manual/electric
Outlets	1x63A, 1x32A, 1x16A
Net dimensions (LxWxH)	790x705x680 mm
Net weight	120 kg



KS 12-1E 1/3 ATSR



Max power/Nom. power, 230 V	8,2/8,0 kW
Max power/Nom. power, 400 V	11,5/11,25 kVA
Voltage	230 V/400 V
Engine start	manual/electric
Outlets	1x32A (400 V), 1x32A (230 V) 1x16A (230 V)
Net dimensions (LxWxH)	790x705x680 mm
Net weight	120 kg



KS 15-1E ATSR



Max power	12,5 kW
Nominal power	12,0 kW
Voltage	230 V
Engine start	electric
Outlets	1x63A, 1x32A, 1x16A
Net dimensions (LxWxH)	780x705x680 mm
Net weight	155 kg



KS 15-1E 1/3 ATSR



Max power/Nom. power, 230 V	11,5/11,0 kW
Max power/Nom. power, 400 V	15,6/15,0 kVA
Voltage	230 V/400 V
Engine start	electric
Outlets	1x32A (400 V), 1x63A (230 V)
Net dimensions (LxWxH)	780x705x680 mm
Net weight	155 kg



AUTOMATIC TRANSFER SWITCH

Gasoline generators of KS 12 and KS 15 series are equipped with a universal **8-pin connector** (ATS input) for an automatic transfer switch unit. The **ATS unit** is suitable for single- and three-phase networks; it can operate both in automatic and in manual mode and has Summer/Winter mode.

The ATS (Automatic Transfer Switch) unit automatically starts the generator and transfers load to it when the main power supply is disconnected and automatically stops the generator when the central power supply is restored.

KS ATS 4/32-12

Power	14 kW(230V)/21 kW(400V)
Voltage	230 V/400 V
Current (Max) 230 V	64 A
Current (Max) 400 V	32 A
Net dimensions (LxWxH)	220x150x370 mm
Net weight, kg	5,5 kg

Suitable for models KS 12-1E ATSR, KS 12-1E 1/3 ATSR.

KS ATS 4/32-15

Power	14 kW(230V)/21 kW(400V)
Voltage	230 V/400 V
Current (Max) 230 V	64 A
Current (Max) 400 V	32 A
Net dimensions (LxWxH)	220x150x370 mm
Net weight, kg	5,5 kg

Suitable for models KS 15-1E ATSR, KS 15-1E 1/3 ATSR.





GASOLINE GENERATORS



KS 2900

KS 2900G

KS 3000

KS 3000E

KS 3000G

Voltage, V	230	230	230	230	230
Max power, kW	2,9	2,9	3,0	3,0	3,0
Nominal power, kW	2,5	2,5	2,6	2,6	2,6
Frequency, Hz	50	50	50	50	50
Current, A (max)	12,5	12,5	13,04	13,04	13,04
Outlets	2x16A	2x16A	2x16A	2x16A	2x16A
Fuel tank volume, l	15	15	15	15	15
Working time at 50% load*, h	15	15	15	15	15
LED display	voltage, frequency, working hours				
Noise level LPA (7 m)/LWA, dB	68/93	68/93	68/93	68/93	68/93
Power output DC, V/A	12/8,3	12/8,3	12/8,3	12/8,3	12/8,3
Engine model	KS 200	KS 200	KS 210	KS 210	KS 210
Engine type	gasoline powered one-cylinder, four-stroke air-cooled	LPG/gasoline powered one-cylinder, four-stroke air-cooled	gasoline powered one-cylinder, four-stroke air-cooled		LPG/gasoline powered one-cylinder, four-stroke air-cooled
Engine power, hp/kW	6,5/4,78	6,5/4,78	7,0/5,15	7,0/5,15	7,0/5,15
Crank case volume, cm ³	0,6	0,6	0,6	0,6	0,6
Engine cylinder volume, cm ³	196	196	208	208	208
Power output controller	intelligent voltage stabilization system AVR				
Engine start	manual	manual	manual	manual/electric	manual
Power factor, cos φ	1,0 (230 V)	1,0 (230 V)	1,0 (230 V)	1,0 (230 V)	1,0 (230 V)
Net dimensions (LxWxH), mm	580x430x440	580x430x440	580x430x440	580x430x440	580x430x440
Gross dimensions (LxWxH), mm	610x455x485	610x455x485	610x455x485	610x455x485	610x455x485
Net weight, kg	41,5	43	41,5	46,1	45,4
Gross weight, kg	43,6	47,5	43,6	47,1	47,5
Protection class	IP23M				
QR code					

In models KS 2900, KS 2900G, KS 5000E G alternator with aluminum winding.

*Fuel consumption depends on many factors, such as load, fuel quality, season, altitude, technical condition of the generator.



DUAL FUEL series LPG/gasoline generators from Könnér & Söhnen®. The generator can run on both gasoline and liquefied gas (propane-butane).



Könnér & Söhnen® engines are reliable, high-performance and cost-effective, and conform to European quality standards, including the latest standard of emission **EURO 5**



KS 5000E G KS 7000 KS 7000E KS 7000E-3 KS 7000E ATS

Voltage, V	230	230	230	400	230
Max power, kW	4,5	5,5	5,5	5,5	5,5
Nominal power, kW	4,0	5,0	5,0	5,0	5,0
Frequency, Hz	50	50	50	50	50
Current, A (max)	19,5	23,91	23,91	13,04	23,91
Outlets	2x16A	1x16A, 1x32A	1x16A, 1x32A	1x16A (230 V) 1x16A (400 V)	1x16A, 1x32A
Fuel tank volume, l	25	25	25	25	25
Working time at 50% load*, h	17	17	17	17	17
LED display	voltage, frequency, working hours				
Noise level LPA (7 m)/LWA, dB	70/95	70/95	70/95	70/95	70/95
Power output DC, V/A	12/8,3	12/8,3	12/8,3	12/8,3	12/8,3
Engine model	KS 390	KS 390	KS 390	KS 390	KS 390
Engine type	LPG/gasoline powered one- cylinder, four- stroke air-cooled	gasoline powered one-cylinder, four-stroke air-cooled			
Engine power, hp/kW	13,0/9,56	13,0/9,56	13,0/9,56	13,0/9,56	13,0/9,56
Crank case volume, cm ³	1,1	1,1	1,1	1,1	1,1
Engine cylinder volume, cm ³	389	389	389	389	389
Power output controller	intelligent voltage stabilization system AVR				
Engine start	manual/electric	manual	manual/electric	manual/electric	manual/electric/ auto
Power factor, cos φ	1,0 (230 V)	1,0 (230 V)	1,0 (230 V)	0,8 (400 V)	1,0 (230 V)
Net dimensions (LxWxH), mm	680x545x550	680x545x550	680x545x550	680x545x550	680x545x550
Gross dimensions (LxWxH), mm	700x545x590	700x545x590	700x545x590	700x545x590	700x545x590
Net weight, kg	77	69,2	76,2	80,8	76,8
Gross weight, kg	79,6	71,6	78,6	83,2	78,8
Protection class	IP23M				
QR code					

In models KS 2900, KS 2900G, KS 5000E G alternator with aluminum winding.

*Fuel consumption depends on many factors, such as load, fuel quality, season, altitude, technical condition of the generator.



Built-in ATS (Automatic transfer switch). The generator control panel with the ATS function is equipped with power terminals, ATS switch and ATS operation indicator.



Könnér & Söhnen® engines are reliable, high-performance and cost-effective, and conform to European quality standards, including the latest standard of emission EURO 5



GASOLINE GENERATORS



KS 7000E-3 ATS

KS 7000E-1/3

KS 7000E G

KS 9000E G

KS 10000E

Voltage, V	400	230	400	230	230	230
Max power, kW	5,5	5,5	5,5	5,5	6,5	8,0
Nominal power, kW	5,0	5,0	5,0	5,0	6,0	7,5
Frequency, Hz	50	50		50	50	50
Current, A (max)	9,93	23,91	9,93	23,91	28,3	34,78
Outlets	1x16A (230 V) 1x16A (400 V)	1x16A (400 V) 1x32A (230 V)		1x16A, 1x32A	1x16A, 1x32A	1x16A, 1x32A
Fuel tank volume, l	25	25		25	25	25
Working time at 50% load*, h	17	17		17	15	17
LED display	voltage, frequency, working hours					
Noise level LPA (7 m)/LWA, dB	70/95	70/95		70/95	71/96	71/96
Power output DC, V/A	12/8,3	12/8,3		12/8,3	12/8,3	12/8,3
Engine model	KS 390	KS 390		KS 390	KS 420	KS 440
Engine type	gasoline powered one-cylinder, four-stroke air-cooled			LPG/gasoline powered one-cylinder, four-stroke air-cooled		gasoline powered one-cylinder, four- stroke air-cooled
Engine power, hp/kW	13,0/9,56	13,0/9,56		13,0/9,56	16,0/11,77	18,0/13,24
Crank case volume, cm ³	1,1	1,1		1,1	1,1	1,2
Engine cylinder volume, cm ³	389	389		389	420	440
Power output controller	intelligent voltage stabilization system AVR					
Engine start	manual/electric/ auto	manual/electric		manual/electric	manual/electric	manual/electric
Power factor, cos φ	0,8 (400 V)	1,0 (230 V)	0,8 (400 V)	1,0 (230 V)	1,0 (230 V)	1,0 (230 V)
Net dimensions (LxWxH), mm	680x545x550	680x545x550		680x545x550	680x545x550	680x545x550
Gross dimensions (LxWxH), mm	700x545x590	700x545x590		700x545x590	700x545x590	700x545x590
Net weight, kg	82,3	81		77,2	83	86,5
Gross weight, kg	83,2	83		79,6	88,9	88,9
Protection class	IP23M					
QR code						

*Fuel consumption depends on many factors, such as load, fuel quality, season, altitude, technical condition of the generator.



DUAL FUEL series LPG/gasoline generators from Könnér & Söhnen®. The generator can run on both gasoline and liquefied gas (propane-butane).



Built-in ATS. Built-in ATS system (automatic transfer switch). ATS unit is already built into the generator, installation is as simple as possible. The generator control panel with the ATS function is equipped with power terminals, ATS switch and ATS operation indicator.



KS 10000E-3 KS 10000E ATS KS 10000E-3 ATS KS 10000E-1/3 KS 10000E G

Voltage, V	400	230	400	230	400	230
Max power, kW	8,0	8,0	8,0	8,0	8,0	8,0
Nominal power, kW	7,5	7,5	7,5	7,5	7,5	7,5
Frequency, Hz	50	50	50	50		50
Current, A (max)	14,45	34,78	14,45	34,78	14,45	34,78
Outlets	1x16A (230 V) 1x16A (400 V)	1x16A, 1x32A	1x16A (230 V) 1x16A (400 V)	1x16A (400 V) 1x32A (230 V)	1x16A, 1x32A	
Fuel tank volume, l	25	25	25	25	25	
Working time at 50% load*, h	15	15	15	15		15
LED display	voltage, frequency, working hours					
Noise level LPA (7 m)/LWA, dB	71/96	71/96	71/96	71/96	71/96	
Power output DC, V/A	12/8,3	12/8,3	12/8,3	12/8,3	12/8,3	
Engine model	KS 440	KS 440	KS 440	KS 440	KS 440	
Engine type	gasoline powered one-cylinder, four-stroke air-cooled					LPG/gasoline powered one-cylinder, four- stroke air-cooled
Engine power, hp/kW	18,0/13,24	18,0/13,24	18,0/13,24	18,0/13,24		18,0/13,24
Crank case volume, cm ³	1,2	1,2	1,2	1,2		1,2
Engine cylinder volume, cm ³	440	440	440	440		440
Power output controller	intelligent voltage stabilization system AVR					
Engine start	manual/electric	manual/electric/ auto	manual/electric/ auto	manual/electric	0,8 (400 V)	1,0 (230 V)
Power factor, cos φ	0,8 (400 V)	1,0 (230 V)	0,8 (400 V)	1,0 (230 V)	0,8 (400 V)	1,0 (230 V)
Net dimensions (LxWxH), mm	680x545x550	680x545x550	680x545x550	680x545x550		680x545x550
Gross dimensions (LxWxH), mm	700x545x590	700x545x590	700x545x590	700x545x590		700x545x590
Net weight, kg	88,0	87,8	89,2	88		86,5
Gross weight, kg	90,4	90,2	91,6	90		88,9
Protection class	IP23M					
QR code						

*Fuel consumption depends on many factors, such as load, fuel quality, season, altitude, technical condition of the generator.

Voltage transfer switch system. Allows using the generator both in three-phase mode (400V) and in single-phase mode (230V) without loss of power.



Könnner & Söhnen® engines are reliable, high-performance and cost-effective, and conform to European quality standards, including the latest standard of emission EURO 5

GASOLINE GENERATORS



GASOLINE GENERATORS



KS 12-1E ATSR

KS 12-1E 1/3 ATSR

KS 15-1E ATSR

KS 15-1E 1/3 ATSR

Voltage, V	230	230	400	230	230	400
Max power	9,2 kW	8,2 kW	11,5 kVA	12,5 kW	11,5 kW	15,6 kVA
Nominal power	9,0 kW	8,0 kW	11,25 kVA	12,0 kW	11,0 kW	15,0 kVA
Frequency, Hz	50	50		50	50	
Current, A (max)	40	35	17	53	48	22
Outlets	1x63A (230 V) 1x32A (230 V) 1x32A (230 V)	1x32A (400 V) 1x32A (230 V) 1x16A (230 V)		1x63A (230 V) 1x32A (230 V) 1x16A (230 V)	1x63A (230 V) 1x32A (400 V)	
LED display	voltage, frequency, working hours, oil alarm					
Noise level L _{PA} (7 m)/L _{WA} , dB	74/97	74/97		73/96	73/96	
Power output DC, V/A	+	+		+	+	
Engine model	KS 650	KS 650		KS 780	KS 780	
Engine type	gasoline powered one-cylinder, four-stroke air-cooled			gasoline powered two-cylinder, four-stroke air-cooled		
Engine power, hp/kW	18,5/13,6	18,5/13,6		22,0/16,18	22,0/16,18	
Crank case volume, cm ³	1,4	1,4		1,5	1,5	
Engine cylinder volume, cm ³	625	625		750	750	
Power output controller	intelligent voltage stabilization system AVR					
Engine start	manual/electric	manual/electric		electric	electric	
Power factor, cos φ	1,0 (230 V)	1,0 (230 V)	0,8 (400 V)	1,0 (230 V)	1,0 (230 V)	0,8 (400 V)
Battery, Ah	21			36		
Ability to connect ATS (8-pin connector)	+	+		+	+	
Net dimensions (LxWxH), mm	790x705x680	790x705x680		780x705x680	780x705x680	
Gross dimensions (LxWxH), mm	800x715x780	800x715x780		807x715x905	807x715x905	
Net weight, kg	120	120		155	155	
Gross weight, kg	136	136		170	170	
Protection class	IP23M					
QR code						



Automatic transfer switch. The generator has the ability to connect the ATS system (automatic transfer switch). The ATS input has a 8-pin connector.



Voltage transfer switch system. Allows using the generator both in three-phase mode (400V) and in single-phase mode (230V) without almost no loss of power.

TRANSPORTATION KITS

KS 3 KIT



Suitable for all open frame models of gasoline generators: KS 2000, KS 3000 series

Mounting kit	1 pc
Wheels	2 pcs
Handles	2 pcs
Support legs	2 pcs
Net/Gross weight	5,0/5,6 kg



KS 7 KIT



Suitable for all open frame models of gasoline generators: KS 5000, KS 7000 series (steel frame Ø28 cm).

Mounting kit	1 pc
Wheels	2 pcs
Handles	2 pcs
Support legs	2 pcs
Net/Gross weight	5,12/5,66 kg



KS 10 KIT



Suitable for all open frame models of gasoline generators: KS 9000, KS 10000 series (steel frame Ø32 cm).

Mounting kit	1 pc
Wheels	2 pcs
Handles	2 pcs
Support legs	2 pcs
Net/Gross weight	5,24/5,78 kg



GASOLINE GENERATORS

DIESEL GENERATORS

 5.0 – 8.0 kW



Könnert & Söhne® diesel generators of the "HEAVY DUTY" series are models of generators for a backup power source that have a number of advantages compared to gasoline models, namely:

- increased motor resource - so they have a longer service life.
- can work more hours without a break
- lower fuel consumption
- have a reinforced frame structure and high-strength components.

The updated range includes one- and two-cylinder models with air or water cooling with a capacity of 5,0 kW to 8,0 kW.



Könnert & Söhner® diesel generators of the "HEAVY DUTY" series have an increased motor resource - so they have a longer service life, can work for more hours without a break.

The new range includes interesting models equipped with a unique VTS phase switching system that allows one generator to be used as a single- and three-phase generator with almost no loss of power. Moreover, diesel generators are equipped with a ATS output for connecting an automatic transfer switch unit. All HEAVY DUTY series generators are equipped with a preheater that will help easily start the generator in winter time. The generators are also equipped with heavyduty 30 Ah batteries.

Generator power



5.0 – 7.5 kW

Voltage



230V/400V

Engine start



MANUAL/ELECTRIC

Engine power



12 – 18 HP

✓ Maximum degree of equipment and user protection: automatic circuit breakers in case of overload or short circuit, generator grounding screw and connectors grounding in each outlet, automatic engine stop at low oil level.

✓ Control of all key indicators of working condition: display of frequency, voltage, low oil level indicator, fuel level sensor.



VTS phase switching system
ensures almost equal power for single and three-phase consumers

LED-display: voltage, frequency, working hours

Pre-start heating procedure for an easy start (in cold season)

6-pin ATS input



Powerful and reliable engine Könnert & Söhner®, engine life up to 3000 hours

DIESEL GENERATORS



3D REVIEW



REVIEW VIDEO OF GENERATOR IN WORK





PRE-START HEATING

HEAVY DUTY series diesel generators are equipped with a preheater that allows to effortlessly start the generator in winter.



ATS INPUT

The generator is suitable for connecting the ATS (automatic transfer switch) system. The ATS input features a 6-pin connector. The ATS (Automatic transfer switch) unit automatically starts the generator and transfers load to it when the main power supply is disconnected.



SYSTEM VTS

The unique innovative VTS system (voltage Transfer Switch) which allows you to use one generator both for single-phase (230 V) and three-phase appliances (400 V). Each mode has its own circuit breaker.



LED DISPLAY

Modern multifunction LED-display shows frequency, voltage and operating hours of the generator. Displayed information makes it easy to determine the generated voltage and maintain generator in time.

KS 6100HDE KS 6102HDE



Max power/Nom. power, 230 V	5,5 kW/5,0 kW
Voltage	230 V
Engine start	manual/electric
Outlets	1x32A (230 V), 2x16A (230 V)
Preheater	+
Battery	30 Ah
Net dimensions (LxWxH)	730x495x630 mm
Net weight	107 kg



KS 8100HDE KS 8102HDE



Max power/Nom. power, 230 V	6,5 kW/6,0 kW
Voltage	230 V
Engine start	manual/electric
Outlets	1x32A (230 V), 2x16A (230 V)
Preheater	+
Battery	30 Ah
Net dimensions (LxWxH)	730x495x630 mm
Net weight	117 kg



KS 8100HDE-1/3 ATSR KS 8102HDE-1/3 ATSR



Max power/Nom. power, 230 V	5,5/5,0 kW
Max power/Nom. power, 400 V	6,5/6,0 kW
Voltage	230 V/400V
Engine start	manual/electric
Outlets	1x32A (230 V), 2x16A (400 V)
Preheater	+
Battery	30 Ah
Net dimensions (LxWxH)	730x495x630 mm
Net weight	117 kg



KS 9100HDE-1/3 ATSR KS 9102HDE-1/3 ATSR



Max power/Nom. power, 230 V	6,5/6,0 kW
Max power/Nom. power, 400 V	7,5/7,0 kW
Voltage	230 V/400V
Engine start	manual/electric
Outlets	1x32A (230 V), 2x16A (400 V)
Preheater	+
Battery	30 Ah
Net dimensions (LxWxH)	730x495x630 mm
Net weight	122 kg

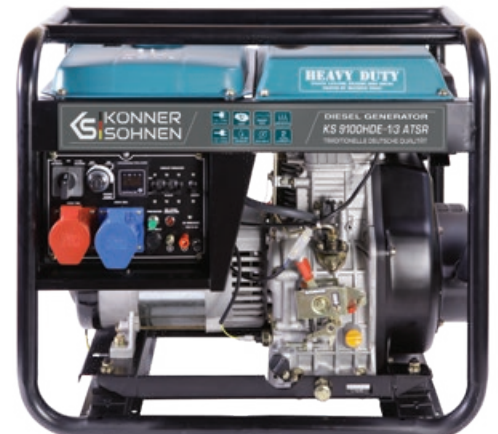

DIESEL GENERATORS

Engines of diesel generators meet the latest Euro 5 emission standard

DIESEL GENERATORS

Exclusive models of **HEAVY DUTY Silent Diesel Generator** series - diesel generators in a soundproof anti-vandal housing. These models have many advantages compared to ordinary diesel generators. Thanks to their robust housing, the generators have reduced noise level, additional protection from all weather conditions, dust and dirt.

Like other generators of HEAVY DUTY series, these models feature increased service life (up to 3000 operating hours), pre-start heating, which is especially necessary for startup during the cold season. In addition, generators are suitable for connecting the ATS unit (Automatic Transfer Switch). Models which have 1/3 in model name are equipped with a unique VTS phase switching system. We are sure that our generators will become your reliable assistants.

Generator power



5.0 – 8.0 kW

Voltage



230V/400V

Soundproof housing



Lpa (7m) – 66 dB

Preheater



**EASY START
IN COLD SEASON**



Soundproof anti-vandal housing

Pre-start heating procedure for an easy start (in cold season)

6-pin ATS input

Circuit breaker.
Overload and short circuit protection



VTS phase switching system ensures almost equal power for single and three-phase consumers

SUPER SILENT DIESEL GENERATORS
(models KS 9300DE 1/3 ATSR, KS 11-2DE ATSR)
Minimum noise level of Lpa (7m) - 66 dB





HOUSING

All-season soundproof anti-vandal housing provides effective protection for the generator and extends its service life. The housing is equipped with handles and casters for easy handling. Models of the Super Silent series with a minimal noise level, provide the most comfortable use.



USER-FRIENDLY ERGONOMIC CONTROL PANEL

The ergonomic generator control panel allows easy operation thanks to the convenient location of all functions: modern LED-display (hour meter, frequency, voltage), electric start, overload circuit breaker, low oil level sensor, outlets, grounding connector, etc.



VTS SYSTEM

Universal generators 2 in 1 have a unique VTS (Voltage Transfer Switch) phase switching system, which allows using a single generator both in single-phase (230V) and in three-phase mode (400V) with almost no loss of power. Each mode has its own circuit breakers. There is no need to use two separate generators.



SUITABLE FOR CONNECTING ATS

The generator is suitable for connecting the ATS (Automatic transfer switch) unit. The ATS input features a 6-pin connector. The ATS (Automatic transfer switch) unit automatically starts the generator and transfers load to it when the main power supply is disconnected.

DIESEL GENERATORS



KS 820HDES-1/3 ATSR

Max power/Nom. power, 230 V	5,5/5,0 kW
Max power/Nom. power, 400 V	6,5/6,0 kW
Voltage	230 V / 400 V
Engine start	electric
Outlets	1x32A (230 V) 1x16A (400 V)
Preheater	+
Battery	30 Ah
Net dimensions (LxWxH)	900x545x905 mm
Net weight	163 kg



KS 920HDES-1/3 ATSR KS 9202HDES-1/3 ATSR

Max power/Nom. power, 230 V	6,5/6,0 kW
Max power/Nom. power, 400 V	7,5/7,0 kW
Voltage	230 V / 400 V
Engine start	electric
Outlets	1x32A (230 V) 1x16A (400 V)
Preheater	+
Battery	30 Ah
Net dimensions (LxWxH)	900x545x905 mm
Net weight	168 kg



 Engines of diesel generators meet the latest Euro 5 emission standard



SUPER SILENT DIESEL GENERATORS

Models of the KS 9300 and KS 11-2 series are equipped with a specially designed soundproof, anti-vandal casing of increased hardness, which ensures the most comfortable use in heavy duty conditions with a **minimum noise level** of Lpa (7m) 66 dB.



Soundproof housing:

- ✔ Noise-absorbing material for ensuring quieter operation of generator
- ✔ Protection of the engine from accidental entry of foreign objects (branches, leaves, construction debris, etc.)
- ✔ Electrostatic anti-corrosion ANTI-SCRATCH coating extends the operation life of the unit
- ✔ Equipped with locks to protect from unauthorized intervention
- ✔ Equipped with handles and transport wheels for convenient movement

KS 9300DE-1/3 ATSR KS 9302DE-1/3 ATSR



Max power/Nom. power, 230 V	6,5/6,0 kW
Max power/Nom. power, 400 V	7,5/7,0 kW
Voltage	230 V / 400 V
Engine start	electric
Outlets	1x32A (230 V) 1x16A (400 V)
Preheater	+
Battery	30 Ah
Net dimensions (LxWxH)	1080x550x800 mm
Net weight	168 kg



KS 11-2DE ATSR



Max power 230 V	8,0 kW
Nominal power 230 V	7,5 kW
Voltage	230 V
Engine start	electric
Outlets	1x32A (230 V) 2x16A (230 V)
Preheater	+
Battery	30 Ah
Net dimensions (LxWxH)	1100x600x750 mm
Net weight	216 kg



DIESEL GENERATORS

Engines of diesel generators meet the latest Euro 5 emission standard



KS 6100HDE
KS 6102HDE







KS 8100HDE
KS 8102HDE



KS 8100HDE-1/3 ATSR
KS 8102HDE-1/3 ATSR



KS 9100HDE-1/3 ATSR
KS 9102HDE-1/3 ATSR

Voltage, V	230	230	230	400	230	400
Max power, kW	5,5	6,5	5,5	6,5	6,5	7,5
Nominal power, kW	5,0	6,0	5,0	6,0	6,0	7,0
Frequency, Hz	50	50	50		50	
Current, A (max)	23,91	28,26	23,04	11,74	27,83	13,54
Outlets	1x16A 1x32A	1x16A 1x32A	1 x 16A (400 V) 1 x 32A (230 V)		1 x 16A (400 V) 1 x 32A (230 V)	
Fuel tank volume, l	11	11	11		11	
Working time at 50% load*, h	8,5	6,9	6,9		6,1	
LED display	voltage, frequency, working hours					
Noise level Lpa (7m)/Lwa, dB	71/96	71/96	71/96		71/96	
Power output DC, V/A	12/8,3	12/8,3	12/8,3		12/8,3	
Engine model	KS 440HD KS 440HD-V	KS 480HD KS 480HD-V	KS 480HD KS 480HD-V		KS 520HD KS 520HD-V	
Engine type	diesel powered one-cylinder, four-stroke air-cooled					
Engine power, hp/kW	12,0/8,83	14,0/10,3	14,0/10,3		18,0/13,24	
Crank case volume, l	1,65	1,65	1,65		1,65	
Engine cylinder volume, cm ³	418	456	456		498	
Power output controller	intelligent voltage stabilization system AVR					
Engine start	manual/electric	manual/electric	manual/electric		manual/electric	
Power factor, cos φ	1,0 (230 V)	1,0 (230 V)	1,0 (230 V)	0,8 (400 V)	1,0 (230 V)	0,8 (400 V)
Diameter of the frame	32 mm, round					
Battery, Ah	30	30	30		30	
Ability to connect ATS	-	-	+		+	
Preheater	+	+	+		+	
Net dimensions (LxWxH), mm	730x495x630	730x495x630	730x495x630		730x495x630	
Gross dimensions (LxWxH), mm	750x550x670	750x550x670	750x550x670		750x550x670	
Net weight, kg	107	117	117		122	
Gross weight, kg	115	125	125		130	
Protection class	IP23M					
QR code						

*Fuel consumption depends on many factors, such as load, fuel quality, season, altitude, technical condition of the generator.



Können & Söhnen® engines are reliable, high-performance and cost-effective, and conform to European quality standards, including the latest standard of emission EURO 5.



Automatic transfer switch. The generator has the ability to connect the ATS system (automatic transfer switch). The ATS input has a 6-pin connector.



Voltage, V	230	400	230	400	230	400	230
Max power, kW	5,5	6,5	6,5	7,5	6,5	7,5	8,0
Nominal power, kW	5,0	6,0	6,0	7,0	6,0	7,0	7,5
Frequency, Hz	50		50		50		50
Current, A (max)	23,91	11,74	28,26	13,54	28,26	13,54	34,78
Outlets	1 x 16A (400 V) 1 x 32A (230 V)		1 x 16A (400 V) 1 x 32A (230 V)		1 x 32A (230 V) 1 x 16A (400 V)		1x32A, 2x16A
Fuel tank volume, l	20		20		20		20
Working time at 50% load*, h	12,5		11,1		11,1		13,2
LED display	voltage, frequency, working hours						
Noise level Lpa (7m)/Lwa, dB	69/94		69/94		66/91		64/89
Power output DC, V/A	12/8,3		12/8,3		12/8,3		12/8,3
Engine model	KS 480HD-V		KS 520HD KS 520HD-V		KS 520HD KS 520HD-V		KS 690HD
Engine type	diesel powered one-cylinder, four-stroke air-cooled						
Engine power, hp/kW	14,0/10,3		18,0/13,24		18,0/13,24		15,0/11,03
Crank case volume, l	1,65		1,65		1,65		1,65
Engine cylinder volume, cm ³	456		498		498		668
Power output controller	intelligent voltage stabilization system AVR						
Engine start	electric		electric		electric		electric
Power factor, cos φ	1,0 (230 V)		1,0 (230 V)	0,8 (400 V)	1,0 (230 V)	0,8 (400 V)	1,0 (230 V)
Housing	soundproof housing						
Battery, Ah	30		30		30		30
Ability to connect ATS	+		+		+		+
Preheater	+		+		+		+
Net dimensions (LxWxH), mm	900x545x905		900x545x905		920x580x860		1100x600x750
Gross dimensions (LxWxH), mm	960x550x960		960x550x960		940x600x880		1150x650x850
Net weight, kg	163		168		168		216
Gross weight, kg	173		178		180		230
Protection class	IP23M						
QR code							

*Fuel consumption depends on many factors, such as load, fuel quality, season, altitude, technical condition of the generator.

VTS Voltage transfer switch system. Allows using the generator both in three-phase mode (400V) and in single-phase mode (230V) without almost no loss of power.

SUPER SILENT. Models of the Super Silent series with a minimal noise level, provide the most comfortable use.

FACTS ABOUT K&S GENERATORS

✓ THE QUALITY IS UNDER CONTROL

We constantly monitor the production process of equipment, even for models, which quality is proved by time. From each order we take about 25% of each Könnert & Söhne® diesel generator article and additionally test them in our own service center in Europe. In this way, we check the proper quality of the batch before it is accepted for sale. All Könnert & Söhne® equipment has European quality certificates, including the modern EURO 5 standard.

✓ FULL POWER

The power range of Könnert & Söhne® diesel generators allows you to choose the ideal model for your home or small business. Universal models are suitable for single-phase and three-phase devices, equipped with protected power sockets for convenient external connecting of consumers with the possibility of receiving the full power produced by the device. The delivery set includes power plugs corresponding to each outlet.

✓ START-UP ASSISTANT

We offer customers a whole package of materials-assistants for commissioning and first start-up, namely a detailed photo manual with a step-by-step process of preparation and start-up generator and video materials that carefully show the entire process of starting both manual and electric start. In addition, the delivery set includes technical instructions for installation and assembly, and a short text hint for starting is attached to the generator, if necessary to remind the sequence of actions.



AUTOMATIC TRANSFER SWITCH

The **ATS** (automatic transfer switch) **unit** automatically starts the generator and transfers the load to it when the main power source is turned off and automatically stops the generator when the central power supply is restored.

Diesel generators with electric starters are equipped with a connector for an automatic transfer switch unit (ATS input). The ATS unit has a controller that allows you to program the time before the generator automatically starts in the case of a power outage, the generator warm-up time before connecting the load and signals an error. ATS unit has an emergency stop button. It can operate both in automatic and in manual mode.

6-pin input for ATS



KS ATS 1/40HD

Power	9,2 kW
Voltage	230 V
Current (Max) 230 V	40 A
Net dimensions (LxWxH)	345x250x180 mm
Net/Gross weight	6,7/7,1 kg



6-pin input for ATS



KS ATS 4/63HD

Power 230 V	14,4 (28,8) kW
Power 400 V	34,8 kW
Voltage	230 V/400V
Current (Max) 230 V	63 (120) A
Current (Max) 400 V	63 A
Net dimensions (LxWxH)	400x320x190 mm
Net/Gross weight	8,4/8,8 kg



PROGRAMMABLE LOGIC CONTROLLER OF THE ATS UNIT:

- Automatic/manual operation
- Programming of engine starting time after power outage
- Programming of engine warm-up time before connecting the appliances
- Setting of starter operation time
- Battery charging when the generator is off

TRANSPORTATION KIT



KS 6-9 KIT

Suitable for all modifications of diesel generators with open frame: **KS 6000, KS 8000, KS 9000**

Wheels	4 pcs
Net/Gross weight	3,0/3,2 kg





INVERTER GENERATORS



1.8 – 8.5 kW



Updated wide model range of inverter generators Könnér & Söhnen® with extended functionality and power range from 1.8 to 8.5 kW includes dual-fuel models (LPG/gasoline), models with the possibility of connecting ATS unit (automatic transfer switch), models with a minimum noise level Lpa (7m) from 62 dB.

Built-in electronic unit with microprocessor control monitors the operation of the generator and provides the most stable 50 Hz frequency and a voltage of 230 V, which is best suitable for sensitive and high precision electronics.



Inverter gasoline powered generators are a user-friendly portable source of energy. The range of inverter generators features models with a power range from 1,8 to 8,5 kW. Double conversion of electric energy provides the pure sine wave and frequency of 50 Hz, which ensures reliable operation of sensitive and high-precision electronics: computers, electronic measuring instruments, medical devices, heating boilers, etc.

All generators are based on robust Könnner & Söhnen® gasoline engines manufactured under license of Dimax International GmbH (Germany), which have passed many-hours-long and multiple-level quality tests and found compliant with all European quality standards, including the latest EURO 5 emission standard. Engines of inverter generators from Könnner & Söhnen® have an Economy mode, which allows using the generator at low speeds and reduces fuel consumption by up to 50%. The wide updated range will help to pick up a model even for the most demanding consumer. Parallel connection of two generators ensures total output of nominal power of two generators.

Generator power



1,8 kW–8,5 kW

Voltage



230 V

Engine start



MANUAL/ELECTRIC

Engine power



2,5–16 HP

Вбудована система ABP (ATS)

Economy mode switch (ECON)

Oil level indicator, overload indicator, voltage indicator, ATS operation indicator, ATS operation errors

PURE SINE WAVE



Exclusive design. Soundproof housing with minimum noise level Lpa (7m) 64 dB

Engine switch (multifunction engine switch for model KS 4000iEG S)

LED display (multifunctional LED display for model KS 4000iE S)

Powerful and reliable EURO 5 engine of Könnner & Söhnen®



Possibility for parallel connection (additional device for double power receiving)



3D REVIEW



REVIEW VIDEO OF GENERATOR IN WORK



INVERTER GENERATORS



INVERTER GENERATORS



Inverter generators in a sound-proof housing are characterized by quiet operation with a minimum noise level of $L_{pA}(7m) 62 \text{ dB}$. They do not cause discomfort neither to the owner nor to others, so they can be safely used for active recreation in nature, as well as for out-of-town trade or concert events, etc.

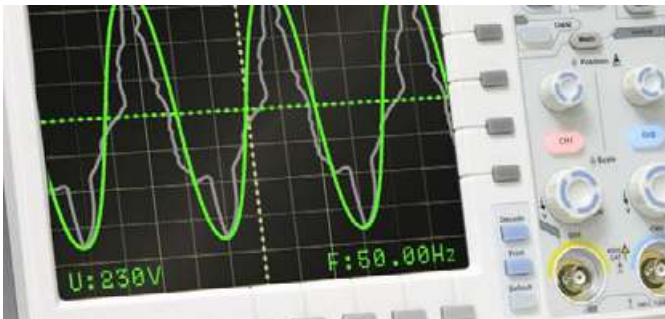

PURE SINE WAVE

The integrated microprocessor-controlled electronic unit controls the generator operation and provides the most stable frequency of 50 Hz and voltage of 230 V. This makes the generator ideally suited for sensitive and high-precision electronics, electronic measuring instruments, medical devices, heating boilers, etc.



ECONOMY MODE

Engines of inverter generators from Köner & Söhnen® have an ECONOMY MODE. This mode allows using the inverter generator at low speeds and reduces fuel consumption by up to 50%. The air choke control system adjusts the engine speed depending on the load.



3-IN-1 EASY ENGINE START SYSTEM

3-in-1 universal engine switch for the easiest and most convenient start of the generator combines the functions of a fuel valve, an air choke and an electric engine start.



HOUSING

Inverter generators from Köner & Söhnen® have two types of execution: soundproof housing with a minimum noise level and a more economical execution with an open frame.

KS 2000i S



Max/Nominal power	2,0 kW/1,8 kW
Voltage	230 V
Engine start	manual
Outlets	1x16A
Net dimensions (LxWxH)	480x280x460 mm
Net weight	19 kg



KS 2100i S



Max/Nominal power	2,0 kW/1,8 kW
Voltage	230 V
Engine start	manual
Outlets	1x16A
Net dimensions (LxWxH)	480x290x430 mm
Net weight	18,5 kg



KS 3100i S



Max/Nominal power	3,1 kW/2,8 kW
Voltage	230 V
Engine start	manual
Outlets	1x16A
Net dimensions (LxWxH)	480x290x430 mm
Net weight	21,5 kg



KS 3300i



Max/Nominal power	3,3 kW/3,0 kW
Voltage	230 V
Engine start	manual
Outlets	2x16A
Net dimensions (LxWxH)	435x375x455 mm
Net weight	25,5 kg



*For models KS 2100i S, 3100i S and 5500iES ATSR cables for parallel connection included.

GENERATOR PARALLEL CONNECTION UNIT

KS PU1 generator parallel connection box from Könnér & Söhnen® allows to increase the total output power of generators by connecting two inverter generators together.

KS PU1

Voltage	230 V
Sockets	1x16A, 1x32A
Circuit breaker	+
Maximum power	7 kW
Cable length	2x80 cm
Cable	AWG 2,08 mm ²
Net weight	1,37 kg





INVERTER GENERATORS



Könnner & Söhnen® inverter generators are the best solution for the reliable operation of modern sensitive equipment.

ABILITY TO CONNECT ATS

Inverter generators from Könnner & Söhnen® with the possibility of connecting the ATS system (Automatic Transfer Switch). The ATS is purposed for automatic start of the generator set in the event of interruption or failure of the main power source, as well as for stopping the generator after power supply has been restored.



KS 4000iE S

Max/Nominal power	4,0 kW/3,5 kW
Voltage	230 V
Engine start	manual/electric
ATS input	+
Outlets	2x16A
Net dimensions (LxWxH)	620x440x510 mm
Net weight	40 kg



KS 4100iE

Max/Nominal power	4,0 kW/3,6 kW
Voltage	230 V
Engine start	manual/electric
ATS input	+
Outlets	2x16A
Net dimensions (LxWxH)	530x410x430 mm
Net weight	36,7 kg



KS 5500iES ATSR



Max/Nominal power	5,5 kW/5,0 kW
Voltage	230 V
Engine start	manual/electric
ATS input	+
Outlets	1x16A, 1x32A
Net dimensions (LxWxH)	610x470x535 mm
Net weight	52 kg



KS 6000iE S



Max/Nominal power	5,5 kW/5,0 kW
Voltage	230 V
Engine start	manual
ATS input	+
Outlets	1x16A, 1x32A
Net dimensions (LxWxH)	590x390x547 mm
Net weight	39,5 kg



KS 8100iE ATSR



Max/Nominal power	8,5 kW/8,0 kW
Voltage	230 V
Engine start	electric
ATS input	+
Outlets	1x16A, 1x32A
Net dimensions (LxWxH)	600x510x560 mm
Net weight	68 kg



*For models KS 2100i S, 3100i S and 5500iES ATSR cables for parallel connection included.

AUTOMATIC TRANSFER SWITCH

The KS ATS 4/25 Gasoline ATS (Automatic Transfer Switch) unit from the German brand "Könnér & Söhnen" automatically starts the generator and transfers load to it when the main power source is turned off and automatically stops the generator when the central power supply is restored.

8-pin input for ATS

7-pin input for ATS

	KS ATS 4/25 Gasoline	KS ATS 4/25 Inverter
Power 230 V	5,75 (11,5) kW	5,75 (11,5) kW
Power 400 V	13 kW	13 kW
Voltage	230 V/400 V	230 V/400 V
Current (Max) 230V	25A (50A)	25A (50A)
Current (Max) 400V	25A (50A)	25 A
Net dimensions (LxWxH)	320x250x140 mm	320x250x140 mm
Net weight	6,0 kg	4,9 kg
Gross weight	6,5 kg	5.75 kg



Model KS ATS 4/25 Gasoline is compatible with inverter generators KS 4000iE S, KS 4100iE and KS 8100iE ATSR. Model KS ATS 4/25 Inverter is compatible only with inverter generator KS 5500iES ATSR.

EXCLUSIVE NOVELTY!

BUILT-IN ATS SYSTEM (AUTOMATIC TRANSFER SWITCH)



A unique novelty! Inverter generators Könnér & Söhnen® with **built-in ATS system** (automatic transfer switch).

This system allows generator to monitor central power availability and to automatically switch itself on when the electricity is turned off and then automatically switch off when the power is available again. The function becomes irreplaceable and extremely convenient in buildings with severe temperature or light conditions in the absence of personnel control.

These generators do not require any additional sophisticated equipment to use ATS system. ATS unit is already built into the generator, installation is as simple as possible and the cost of these models is highly affordable.

KS 4000iE S ATS



Max/Nominal power	4,0 kW/3,5 kW
Voltage	230 V
Engine start	manual/electric/auto
ATS	built-in ATS
Outlets	2x16A
Net dimensions (LxWxH)	620x440x510 mm
Net weight	40 kg



KS 6000iE S ATS



Max/Nominal power	5,5 kW/5,0 kW
Voltage	230 V
Engine start	manual/electric/auto
ATS	built-in ATS
Outlets	1x32A
Net dimensions (LxWxH)	590x390x547 mm
Net weight	40 kg



BUILT-IN ATS SYSTEM

Built-in ATS (automatic transfer switch) system - the generator is equipped with an automatic transfer switch function. The built-in ATS unit allows the generator to monitor the incoming mains supply, automatically starts the generator when the mains supply is disconnected and then automatically stops the generator when the mains supply is restored with no user intervention.

THE POSSIBILITY OF AUTOMATIC OPERATION WITHOUT THE NEED FOR PERMANENT INSTALLATION!

The KS 4000iES ATS and KS 6000iES ATS inverter generators from Könnér & Söhnen® are equipped with internal AVR modules, providing a wide range of, sometimes unique, solutions for backup power. They come in multiple configurations and can be used to power individual electrical devices as well as provide electricity for entire structures such as homes, offices, shops, and more.

These exclusive models of inverter generators from Könnér & Söhnen® have the capability of automatic operation without the need for a permanent installation.

Version 3 additionally features the capability of external control for starting the generator through the presence of „dry” contacts. This function expands the scope of application for these models and is suitable for use in systems with solar stations (control of programmed contacts of a solar inverter). In this mode, the generator has zero energy consumption in standby.



FEATURES OF THE KS 6000iES ATS - VERSION 3 MODEL

- ✓ The ability to externally control the generator startup is provided through the presence of “dry” contacts.
- ✓ Zero energy consumption in standby mode with external launch.
- ✓ Automatic startup without the need for permanent installation.

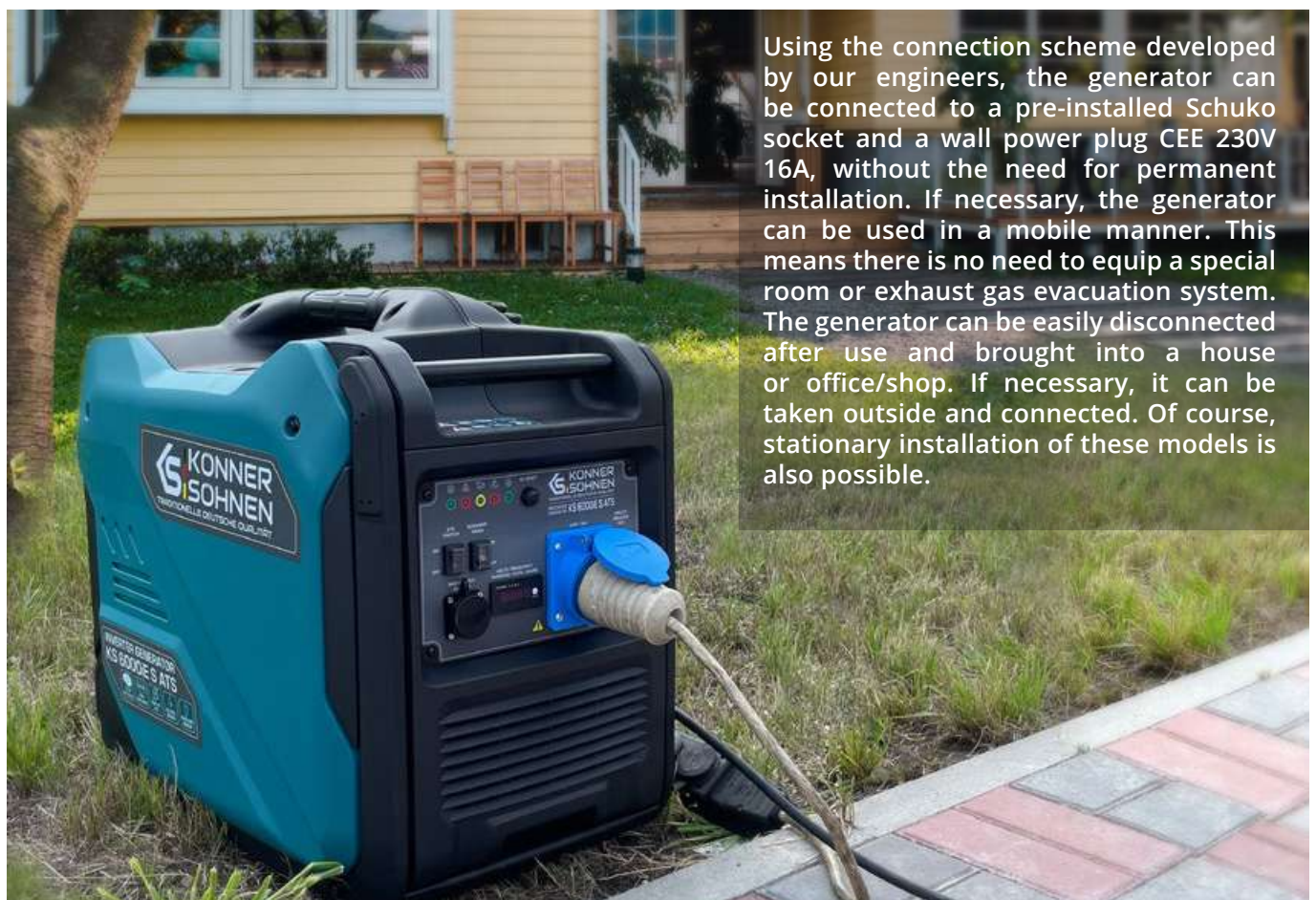

Using the connection scheme developed by our engineers, the generator can be connected to a pre-installed Schuko socket and a wall power plug CEE 230V 16A, without the need for permanent installation. If necessary, the generator can be used in a mobile manner. This means there is no need to equip a special room or exhaust gas evacuation system. The generator can be easily disconnected after use and brought into a house or office/shop. If necessary, it can be taken outside and connected. Of course, stationary installation of these models is also possible.

LPG/GASOLINE INVERTER GENERATORS

DUAL FUEL series LPG/gasoline generators from Könnér & Söhnen® can run on both gasoline and liquefied gas (propane-butane). The package includes everything you need to use LPG as fuel.



DUAL FUEL generators from Könnér & Söhnen® are equipped with a hose with a reducer (DIN 477 standard) for connecting to a gas cylinder. The reducer ensures the reliability of the gas connection.

All models are based on robust engines, which meet all European quality standards, including EURO 5. Engines of K&S inverter generators have an Economy mode, which allows using the generator at low speeds and reduces fuel consumption by up to 50%. Alternator with copper winding and high-performance K&S engine guarantee trouble-free and long-term operation and meet all European quality standards. The LED display makes it possible to monitor the operation of the generator and to carry out its maintenance in time.

Generator power



1,8 kW–8,5 kW

Voltage



230V

Engine start



MANUAL/ELECTRIC

Engine power

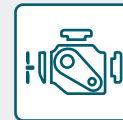

2,5–16 HP

Hosepipe with reducer (standard DIN 477)

LED display: operating hours, frequency, voltage, oil alarm

Soundproof housing with minimal noise level

Output for gas cylinder connection



Powerful and reliable EURO 5 engine of Könnér & Söhnen®

ECONOMY MODE switch

Generator parallel connection outputs



3D REVIEW



REVIEW VIDEO OF GENERATOR IN WORK





LPG/GASOLINE

The generator runs on both gasoline and liquefied gas (propane-butane) and includes everything necessary for using LPG as fuel: a hosepipe with reducer, which provides a reliable connection of a gas cylinder. Just connect the generator to the gas cylinder and start the engine.



ECONOMY MODE

The ergonomic control panel is equipped with a fuel economy mode switch. This mode reduces fuel consumption by up to 50% at small loads due to lower engine revolutions.



HIGH QUALITY ALTERNATOR

Könnér & Söhnen® inverter generators are equipped with a robust brushless alternator with 100% copper winding.



ECONOMICAL CHOICE

In addition to use with a conventional portable gas cylinder, dual-fuel generators of the trademark Könnér & Söhnen® can be connected to the existing distribution LPG system (propane, butane) with a pressure of 30-50 mBar (the hose for connecting to such a system is not included in the delivery set). If necessary, dual fuel models can be easily switched to work on gasoline.

INVERTER GENERATORS



LPG/GASOLINE INVERTER GENERATORS

KS 2000iG S



Max power	2,0 kW*
Nominal power	1,8 kW*
Voltage	230 V
Engine start	manual
Outlets	1x16A
Net dimensions (LxWxH)	500x285x460 mm
Net weight	19 kg



KS 2100iG S



Max power	2,1 kW*
Nominal power	1,8 kW*
Voltage	230 V
Engine start	manual
Outlets	1x16A
Net dimensions (LxWxH)	480x290x430 mm
Net weight	19 kg



KS 3100iG S



Max power	3,1 kW*
Nominal power	2,8 kW*
Voltage	230 V
Engine start	manual
Outlets	1x16A
Net dimensions (LxWxH)	480x290x430 mm
Net weight	22 kg



KS 4000iEG S



Max power	4,0 kW*
Nominal power	3,5 kW*
Voltage	230 V
Engine start	manual/electric
Outlets	2x16A
Net dimensions (LxWxH)	620x440x510 mm
Net weight	40 kg



*LPG operation reduces generator power by 10%.



For models KS 2100iG S, 3100iG S and 5500iES ATSR cables for parallel connection included.

KS 4100iEG



Max power	4,0 kW*
Nominal power	3,6 kW*
Voltage	230 V
Engine start	manual/electric
Outlets	2x16A
Net dimensions (LxWxH)	530x410x430 mm
Net weight	38 kg



KS 5500iEG S



Max power	5,5 kW*
Nominal power	5,0 kW*
Voltage	230 V
Engine start	manual/electric
Outlets	1x16A, 1x32A
Net dimensions (LxWxH)	610x470x535 mm
Net weight	52,5 kg



KS 8100iEG



Max power	8,5 kW*
Nominal power	8,0 kW*
Voltage	230 V
Engine start	electric
Outlets	1x16A, 1x32A
Net dimensions (LxWxH)	600x510x560 mm
Net weight	68 kg



*LPG operation reduces generator power by 10%.



For models KS 2100iG S, 3100iG S and 5500iES ATSR cables for parallel connection included.

LPG/GASOLINE GENERATORS OF DUAL FUEL SERIES FROM KÖNNER & SÖHNEN®:

- ✔ There is no need to add gasoline to the fuel tank to start the generator. The generator can start and run directly on LPG.
- ✔ The most simple connection - all you need is to connect the hose to your cylinder.

- ✔ LPG is a more environmentally friendly fuel than gasoline. The use of gas as fuel provides less emissions of harmful exhaust substances into the atmosphere.
- ✔ Compact size and light weight. Convenient to use, transport and store. Transport wheels make transportation easier and expand the application of these models.



GASOLINE INVERTER GENERATORS



KS 2000i S KS 2100i S KS 3100i S KS 3300i KS 4000i S KS 4000i S ATS

Voltage, V	230	230	230	230	230	230
Max power, kW	2,0	2,0	3,1	3,3	4,0	4,0
Nominal power, kW	1,8	1,8	2,8	3,0	3,5	3,5
Frequency, Hz	50	50	50	50	50	50
Current, A (max)	8,7	8,7	13,5	14,4	17,4	17,4
Outlets	1x16A	1x16A	1x16A	2x16A	2x16A	2x16A
Fuel tank volume, l	5	4	4	7	12	12
Working time at 50% load*, h	6,25	4,5	2,7	7	7,8	7,8
LED display	voltage, frequency, working hours				multifunctional** voltage, frequency, working hours	
Noise level LPA (7 m)/LWA, dB	62/87	62/87	63/88	71/96	66/91	66/91
Power output DC, V/A	-	12/8,3	12/8,3	12/8,3	12/8,3	12/8,3
USB-Outputs	5V/1A, 5V/2,1A	5V/1A, 5V/2,1A	5V/1A, 5V/2,1A	-	-	5V/1A, 5V/2,1A
Engine model	KS 100i	KS 110i	KS 160i	KS 210i	KS 240i	KS 240i
Engine type	gasoline, four-stroke					
Engine power, hp	2,5	3,3	4,6	5,5	7,5	7,5
Crank case volume, cm ³	0,4	0,35	0,45	0,6	0,6	0,6
Engine cylinder volume, cm ³	79,7	79,7	145	208	223	223
Outputs for parallel connection	+	parallel connection cable included		-	+	-
Engine start	manual	manual	manual	manual	manual/electric	manual/electric
Lithium battery, Ah	-	-	-	-	1,6	1,6
ATS input	-	-	-	-	+	built-in ATS
Power factor, cos φ	1,0 (230 V)	1,0 (230 V)	1,0 (230 V)	1,0 (230 V)	1,0 (230 V)	1,0 (230 V)
Net dimensions (LxWxH), mm	480x280x460	480x290x430	480x290x430	435x375x455	620x440x510	620x440x510
Gross dimensions (LxWxH), mm	555x335x540	510x320x475	510x320x475	450x380x480	630x475x570	630x475x570
Net weight, kg	19	18,5	21,5	25,5	40	40
Gross weight, kg	21	21,2	23,9	27,5	43,4	43,5
Protection class	IP23M					
QR code						

*Fuel consumption depends on many factors, such as load, fuel quality, season, altitude, technical condition of the generator.

**Multifunctional LED-display: voltage, frequency, working hours; overload indicator, voltage indicator, oil level indicator.



Könnert & Söhne® engines are reliable, high-performance and cost-effective, and conform to European quality standards, including the latest standard of emission EURO 5



ECONOMY MODE. Engines of inverter generators from Könnert & Söhne have an **ECONOMY MODE**. This mode allows using the inverter generator at low speeds and reduces fuel consumption by up to 50%.



	KS 4100iE	KS 5500iES ATSR	KS 6000iE S	KS 6000iE S ATS	KS 8100iE ATSR
Voltage, V	230	230	230	230	230
Max power, kW	4,0	5,5	5,5	5,5	8,5
Nominal power, kW	3,6	5,0	5,0	5,0	8,0
Frequency, Hz	50	50	50	50	50
Current, A (max)	17,4	23,9	23,9	23,9	34,8
Outlets	2x16A	1x16A, 1x32A	1x16A, 1x32A	1x32A	1x16A, 1x32A
Fuel tank volume, l	12,5	13,5	11	11	20
Working time at 50% load*, h	8,1	8,1	7	7	7,1
LED display	voltage, frequency, working hours	multifunctional**		voltage, frequency, working hours	
Noise level LPA (7 m)/LWA, dB	70/95	66/91	70/95	70/95	70/95
Power output DC, V/A	-	12/8,3	12/8,3	-	12/8,3
USB-Outputs	5V/1A, 5V/2,1A	5V/1A, 5V/2,1A	5V/1A, 5V/2,1A	-	5V/1A, 5V/2,1A
Engine model	KS 240i	KS 330i	KS 240i	KS 240i	KS 480i
Engine type	gasoline, four-stroke				
Engine power, hp	7,5	9,5	7,5	7,5	16
Crank case volume, cm ³	0,6	0,85	0,7	0,7	1,1
Engine cylinder volume, cm ³	223	312	223	223	458
Outputs for parallel connection	-	parallel connection cable included	+	-	-
Engine start	manual/electric				electric
Lithium battery, Ah	1,6	1,6	1,6	1,6	1,6
ATS input	+	+	+	built-in ATS	+
Power factor, cos φ	1,0 (230 V)	1,0 (230 V)	1,0 (230 V)	1,0 (230 V)	1,0 (230 V)
Net dimensions (LxWxH), mm	530x410x430	610x470x535	590x390x547	590x390x547	600x510x560
Gross dimensions (LxWxH), mm	605x420x425	680x510x605	640x425x600	640x425x600	725x505x555
Net weight, kg	36,7	52	39,5	40	68
Gross weight, kg	39	57,8	43	43	74
Protection class	IP23M				
QR code					

*Fuel consumption depends on many factors, such as load, fuel quality, season, altitude, technical condition of the generator.

**Multifunctional LED-display: voltage, frequency, working hours; overload indicator, voltage indicator, oil level indicator.

Built-in ATS. Built-in ATS system (automatic transfer switch). ATS unit is already built into the generator, installation is as simple as possible. The generator control panel with the ATS function is equipped with power terminals, ATS switch and ATS operation indicator.

Automatic transfer switch. The generator has the ability to connect the ATS unit (automatic transfer switch). The ATS input has a 8-pin or 7-pin connector.

INVERTER GENERATORS



LPG/GASOLINE INVERTER GENERATORS



LPG

KS 2000iG S



LPG

KS 2100iG S



LPG

KS 3100iG S



LPG

KS 4000iEG S

Voltage, V	230	230	230	230
Max power, kW	2,0*	2,0*	3,1*	4,0*
Nominal power, kW	1,8*	1,8*	2,8*	3,5*
Frequency, Hz	50	50	50	50
Current, A (max)	8,7	8,7	13,5	17,4
Outlets	1x16A	1x16A	1x16A	2x16A
Fuel tank volume, l	5	4	4	12
Working time at 50% load**, h	6,25	4,5	2,7	7,8
LED display	voltage, frequency, working hours			
Noise level LPA (7 m)/LWA, dB	62/87	62/87	63/88	66/91
Power output DC, V/A	-	12/8,3	12/8,3	12/8,3
USB-Outputs	-	5V/1A, 5V/2,1A	5V/1A, 5V/2,1A	5V/1A, 5V/2,1A
Engine model	KS 100i	KS 110i	KS 160i	KS 240i
Engine type	LPG/gasoline, four-stroke			
Engine power, hp	2,5	3,3	4,6	7,5
Crank case volume, cm ³	0,4	0,35	0,45	0,6
Engine cylinder volume, cm ³	79,7	79,7	145	223
Outputs for parallel connection	+	parallel connection cable included		+
Engine start	manual	manual	manual	manual/electric
Lithium battery, Ah	-	-	-	1,6
Power factor, cos φ	1,0 (230 V)	1,0 (230 V)	1,0 (230 V)	1,0 (230 V)
Net dimensions (LxWxH), mm	500x285x460	480x290x430	480x290x430	620x440x510
Gross dimensions (LxWxH), mm	700x335x540	510x320x475	510x320x475	775x475x570
Net weight, kg	19	19	22	40
Gross weight, kg	21	22,3	24,6	46
Protection class	IP23M			
QR code				

*LPG operation reduces generator power by 10%.

**Fuel consumption depends on many factors, such as load, fuel quality, season, altitude, technical condition of the generator.

LPG **DUAL FUEL series** LPG/gasoline generators from Könner & Söhnen®. The generator can run on both gasoline and liquefied gas (propane-butane).



ECONOMY MODE. Engines of inverter generators from Könner & Söhnen have an **ECONOMY MODE**. This mode allows using the inverter generator at low speeds and reduces fuel consumption by up to 50%.



KS 4100iEG



KS 5500iEG S



KS 8100iEG

Voltage, V	230	230	230
Max power, kW	4,0*	5,5*	8,5*
Nominal power, kW	3,6*	5,0*	8,0*
Frequency, Hz	50	50	50
Current, A (max)	17,4	23,9	34,8
Outlets	2x16A	1x16A, 1x32A	1x16A, 1x32A
Fuel tank volume, l	12,5	13,5	20
Working time at 50% load**, h	8,1	8.4	7,1
LED display	voltage, frequency, working hours	multifunctional***	voltage, frequency, working hours
Noise level LPA (7 m)/LWA, dB	70/95	66/91	70/95
Power output DC, V/A	-	12/8,3	12/8,3
USB-Outputs	5V/1A, 5V/2,1A	5V/1A, 5V/2,1A	5V/1A, 5V/2,1A
Engine model	KS 240i	KS 330i	KS 480i
Engine type	LPG/gasoline, four-stroke		
Engine power, hp	7,5	9,5	16
Crank case volume, cm ³	0,6	0,85	1,1
Engine cylinder volume, cm ³	223	312	458
Outputs for parallel connection	+	parallel connection cable included	-
Engine start	manual/electric	manual/electric	electric
Lithium battery, Ah	1,6	1,6	1,6
ATS input	-	-	-
Power factor, cos φ	1,0 (230 V)	1,0 (230 V)	1,0 (230 V)
Net dimensions (LxWxH), mm	530x410x430	610x470x535	600x510x560
Gross dimensions (LxWxH), mm	685x420x430	765x510x605	765x505x555
Net weight, kg	38	52,5	68
Gross weight, kg	44	63	74
Protection class	IP23M		
QR code			

*LPG operation reduces generator power by 10%.

**Fuel consumption depends on many factors, such as load, fuel quality, season, altitude, technical condition of the generator.

***Multifunctional LED-display: voltage, frequency, working hours; overload indicator, voltage indicator, oil level indicator.

Soundproof housing. Generators in soundproof housing with minimal noise level.



Könnér & Söhnen® engines are reliable, high-performance and cost-effective, and conform to European quality standards, including the latest standard of emission EURO 5



DIESEL INVERTER GENERATORS



 5.0 – 9.5 kW



Diesel inverter generators from Könnér & Söhnen® are rare devices that operate on diesel fuel, produce exceptionally clean power, have an extended engine lifespan, and are equipped with fuel-saving features. Powered by powerful diesel engines, these generators boast an extended service life of up to 3000 operating hours, ensuring long-lasting and reliable power supply, even for modern sensitive devices. They are designed using advanced pure sine wave technology to protect vulnerable electronics from voltage fluctuations, providing unparalleled efficiency at maximum performance.



Economy mode



Automatic transfer switch (ATS)



Pre-start heating

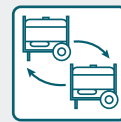

Parallel connection



EXTENDED ENGINE RUNTIME

Generators from the Heavy DUTY series are suitable not only as a backup power source but also for continuous operation. The engine lifespan exceeds 3000 operating hours, as confirmed by multi-level and multi-hour testing, and is backed by a warranty. It is evident that the engines demonstrate such high efficiency when properly operated and maintained.

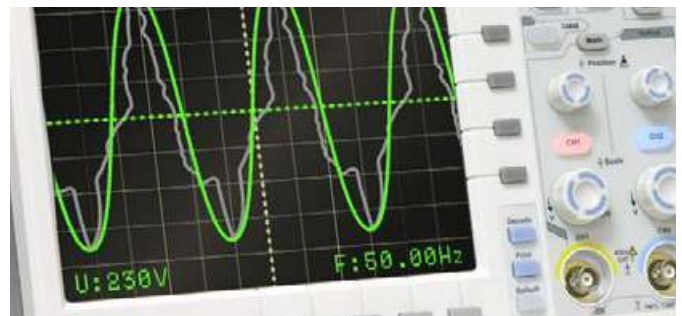

PURE SINE WAVE

The integrated microprocessor-controlled electronic unit controls the generator operation and provides the most stable frequency of 50 Hz and voltage of 230 V. This makes the generator ideally suited for sensitive and high-precision electronics, electronic measuring instruments, medical devices, heating boilers, etc.

KS 51iE-D ATSR

Max power/Nom. power	5.5 kW/5.0 kW
Voltage	230 V
Engine start	manual/electric
ATS input	+
Outlets	1×16A, 1×32A
Pre-start heating	+
Dimensions (LxWxH)	660×510×640 mm
Net weight	98 kg



KS 52iES-D ATSR

Max power/Nom. power	5.5 kW/5.0 kW
Voltage	230 V
Engine start	manualelectric
ATS input	+
Outlets	1×16A, 1×32A
Pre-start heating	+
Dimensions (LxWxH)	930*580*785 mm
Net weight	160 kg



KS 91iE-D ATSR

Max power/Nom. power	9.5 kW/9.0 kW
Voltage	230 V
Engine start	electric
ATS input	+
Outlets	1×16A, 1×32A, 1×63A
Pre-start heating	+
Dimensions (LxWxH)	805×545×720 mm
Net weight	155 kg



These generators also feature the capability of parallel connection, enabling for an increase in the output power. This scalable solution provides the flexibility to adapt to the increased power needs for your home or business. The pre-start heating function facilitates easy engine startup in cold weather.

AUTOMATIC TRANSFER SWITCH

8-pin input for ATS

KS ATS 1/50 D-Inverter

Voltage	230 V
Current (Max.) 230 V	50 A
Net dimensions (LxWxH)	368×251×140 mm
Weight gross/net	5.3 kg



DIESEL POWER PLANT

Diesel power plants of HEAVY DUTY Silent Diesel Generator series from Könnner & Söhnen® are developed on the basis of low-speed engines (1500 rpm) from world-renowned companies that produce engines for the markets of Europe and the USA. Absolute compliance of the engines with the standards of reliability, economy, environmental friendliness, technical and operational safety of power plants is the best confirmation of the high quality of products.

This series of power plants includes units with power from **16 to 30 kVA** for single-phase and three-phase electrical networks based on reliable four-cylinder water-cooled diesel engines.



16 – 33 kVA



THANKS TO THE IMPLEMENTATION OF THE COMPANY'S OWN DEVELOPMENTS AND ADAPTATION TO THE REQUIREMENTS OF KÖNNER & SÖHNEN, ALL POWER PLANTS HAVE A RESERVE OF POWER IN ACCORDANCE WITH THE DECLARED CHARACTERISTICS

DIESEL POWER PLANTS



DIESEL POWER PLANTS

Diesel power plants of the **HEAVY DUTY Silent Diesel Generator series** from German company Könnner & Söhnen take into account all your needs in providing of both emergency and backup power - for longer power supply of residential buildings and small commercial facilities. These are professional units developed with the use of advanced technologies, and at the same time, they are easy-to-use devices that can supply power to both single-phase and three-phase electricity consumers.

All Könnner & Söhnen diesel power plants undergo pre-commissioning preparation and test start-up with control of compliance with all parameters of correct operation in Europe in own service center. Using special loading machine, we check the power produced by the station in various operating modes and adjust the electronic control unit.

Power plant



16 – 30 kVA

Engine speed



1500 RPM

Voltage



230V/400V

Housing



SOUNDPROOF HOUSING

✓ Full pre-sale testing and commissioning works in Europe

✓ European quality certificates and 2 years warranty

Multifunctional digital control unit Datakom D300

Power sockets with protective covers and terminals for external connection of consumers

Emergency stop button

Noise protection to ensure silent operation of the generator

Wide doors provide convenient access to the parts of the unit during maintenance

Reliable low-speed engine 1500 rpm with water cooling

Electronic or mechanical system of engine speed control

Locks on all doors for security and protection

4-pole brushless alternator with automatic system of voltage regulation

Galvanic coating (KS 18-1DE-G, KS 33-3DE-G) for increased wear resistance, strength, resistance to oxidation and corrosion

Forklift holes



LOW SPEED RELIABLE ENGINES

Modern low-speed engine 1500 rpm provides optimal performance, has an increased motor resource for long-term use, thanks to which power plants of the German brand are among the most economical in terms of cost. The electronic engine speed control system (optional) is a computer control that automatically adjusts the engine speed, quickly reacts to load changes, improves the quality of electricity produced and guarantees the maximum stable frequency of 50 Hz.



BRUSHLESS ALTERNATOR

Equipped with a 4-pole brushless current alternator Stamford type, synchronous type, with a self-excitation system and a high-efficiency electronic voltage regulation system AVR.



DIGITAL CONTROLLER

All work processes are managed using a modern multi-function digital control unit. The controller provides verification of all operating state indicators of the power plant, convenient start-up settings and operation of the installation, monitors the battery charge, monitors the engine speed and adjusts the fuel supply depending from load, protects against overheating and low oil level, signals possible malfunctions and also reports about the need for service.



SOUNDPROOF ANTI-VANDAL ENCLOSURE

The high-quality noise-proof housing provides a significant reduction in noise during the operation of the power plant, has improved thermal distribution, protects the power plant from moisture and condensate, from adverse weather conditions and unauthorized intervention. Special galvanic coating (optional) has increased properties of wear resistance, strength, resistance to oxidation and resistance to corrosion.

DIESEL POWER PLANTS



KS 18-1XM

Max power 230 V	17,6 kVA
Nominal power 230 V	16 kVA
Voltage	230 V
Outlets	-
Engine speed monitoring system	mechanical
Battery	85 Ah
Net dimensions (LxWxH)	1850x740x1000 mm
Net weight	732 kg

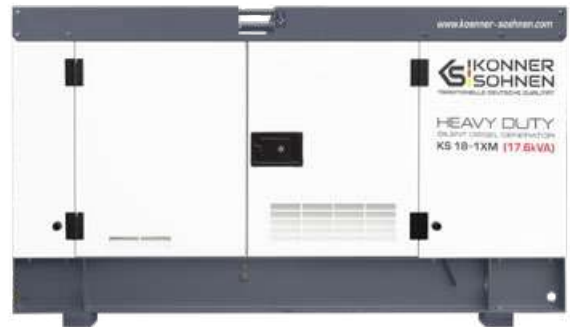

KS 18-1YE

Max power 230 V	17,6 kVA
Nominal power 230 V	16 kVA
Voltage	230 V
Outlets	1x32A (230 V) 2x16A (230 V)
Engine speed monitoring system	electronic
Battery	85 Ah
Net dimensions (LxWxH)	2160x950x1250 mm
Net weight	975 kg



KS 18-1DE-G

Max power 230 V	17,6 kVA
Nominal power 230 V	16 kVA
Voltage	230 V
Outlets	1x32A (230 V) 2x16A (230 V)
Engine speed monitoring system	electronic
Battery	85 Ah
Net dimensions (LxWxH)	2160x950x1250 mm
Net weight	852 kg



KS ATS 4/100HD KS ATS 4/100HD-O



Consumption	18 W
Operating voltage	230 V/400 V
Power 230 V/400 V	23 kW/55 kW
Current (max) 230 V/400 V	100 A
Net dimensions KS ATS 4/100HD	500x300x600 mm
Net dimensions KS ATS 4/100HD-O	415x150x515 mm
Net weight KS ATS 4/100HD	21 kg
Net weight KS ATS 4/100HD-O	5 kg



KS 25-3LM



Max power/Nom. power 400 V	25,3/23 kVA
Voltage	230 V/400 V
Outlets	-
Engine speed monitoring system	mechanical
Battery	85 Ah
Net dimensions (LxWxH)	1700x780x1000 mm
Net weight	680 kg



KS 33-3XM



Max power/Nom. power 400 V	33/30 kVA
Voltage	230 V/400 V
Outlets	-
Engine speed monitoring system	mechanical
Battery	85 Ah
Net dimensions (LxWxH)	1850x780x1000 mm
Net weight	739 kg

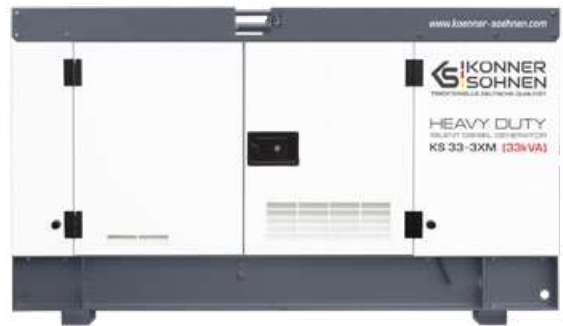

KS 33-3YE



Max power/Nom. power 400 V	33/30 kVA
Voltage	230 V/400 V
Outlets	1x32A (400 V) 1x16A (400 V) 1x16A (230 V)
Engine speed monitoring system	electronic
Battery	2x85 Ah
Net dimensions (LxWxH)	2160x950x1250 mm
Net weight	978 kg



KS 33-3DE-G



Max power/Nom. power 400 V	33/30 kVA
Voltage	230 V/400 V
Outlets	1x32A (400 V) 1x16A (400 V) 1x16A (230 V)
Engine speed monitoring system	electronic
Battery	85 Ah
Net dimensions (LxWxH)	2160x950x1250 mm
Net weight	856 kg





DIESEL POWER PLANTS





KS 18-1XM



KS 18-1YE



KS 18-1DE-G

Number of phases	single-phase	single-phase	single-phase
Voltage, V	230	230	230
Max power, kVA	17,6	17,6	17,6
Nominal power, kVA	16	16	16
Power factor, cosφ	1,0 (230 V)	1,0 (230 V)	1,0 (230 V)
Current, A (max)	76,52	76,52	76,52
Frequency, Hz	50	50	50
Insulation class	H	H	H
ENGINE CHARACTERISTICS			
Engine type	diesel powered four-cylinder, four-stroke water-cooled		
Engine brand	Xinchai	Yangdong	DEUTZ
Engine model	C490BD	YSD490D	BFM3 G1
Engine speed, rpm	1500	1500	1500
Output power, kW	24	21	20
Engine cylinder volume cm ³	2600	2540	3170
Engine speed monitoring system	mechanical	electronic	electronic
Engine heating	+	+	+
GENERAL CHARACTERISTICS			
Controller	Datakom D300	Datakom D300	Datakom D300
Fuel tank volume, l	53	76	55
Fuel consumption at 50% of load*, l/h	3.59	3.7	3.3
Crankcase volume, l	5,5	7	5,5
Coolant volume, l	15	12	10
Noise level Lpa (7m)/Lwa, dB	72/97	72/97	72/97
Housing	noise - proof, moisture-proof, metal, all-weather, vandal-proof		
Housing coating	powder coating	powder coating	electroplating
Battery, Ah	85	85	85
Battery charger	built-in	built-in	built-in
ATS output	+	+	+
Power output controller	intelligent voltage stabilization system AVR		
Protection class	IP24		
Outlets	-	1x32A (230 V) 2x16A (230 V)	1x32A (230 V) 2x16A (230 V)
Net dimensions (LxWxH), mm	1850x740x1000	2160x950x1250	2160x950x1250
Gross dimensions (LxWxH), mm	1880x770x1020	2190x980x1270	2190x980x1270
Net weight, kg	732	975	852
Gross weight, kg	735	978	855
QR code			

*Fuel consumption depends on many factors, such as load, fuel quality, season, altitude, technical condition of the generator.



Automatic transfer switch. The generator has the ability to connect the ATS system (automatic transfer switch).



Number of phases	three-phase		three-phase		three-phase		three-phase	
	230	400	230	400	230	400	230	400
Max power, kVA	25,3		33		33		33	
Nominal power, kVA	23		30		30		30	
Power factor, cosφ	1,0 (230 V)	0,8 (400 V)	1,0 (230 V)	0,8 (400 V)	1,0 (230 V)	0,8 (400 V)	1,0 (230 V)	0,8 (400 V)
Current, A (max)	36,45		47,63		47,63		47,63	
Frequency, Hz	50		50		50		50	
Insulation class	H		H		H		H	
ENGINE CHARACTERISTICS								
Engine type	diesel powered four-cylinder, four-stroke water-cooled							
Engine brand	Laidong		Xinchai		Yangdong		DEUTZ	
Engine model	DPKM490BD		A498BD		Y4100D		BFM3 G2	
Engine speed, rpm	1500		1500		1500		1500	
Output power, kW	23		32		32		29	
Engine cylinder volume cm ³	2545		3170		3707		3168	
Engine speed monitoring system	mechanical		mechanical		electronic		electronic	
Engine heating	+		+		+		+	
GENERAL CHARACTERISTICS								
Controller	Datakom D300		Datakom D300		Datakom D300		Datakom D300	
Fuel tank volume, l	57		75		75		57	
Fuel consumption at 50% of load*, l/h	4,1		4,9		5,1		3,7	
Crankcase volume, l	5,5		5,5		8		5,5	
Coolant volume, l	10		15		14		10	
Noise level Lpa (7m)/Lwa, dB	72/97		72/97		72/97		72/97	
Housing	noise - proof, moisture-proof, metal, all-weather, vandal-proof							
Housing coating	powder coating		powder coating		powder coating		electroplating	
Battery, Ah	85		85		2x85		85	
Battery charger	built-in		built-in		built-in		built-in	
ATS output	+		+		+		+	
Power output controller	intelligent voltage stabilization system AVR							
Protection class	IP24							
Outlets	-		-		1x32A (400 V) 1x16A (400 V) 1x16A (230 V)		1x32A (400 V) 1x16A (400 V) 1x16A (230 V)	
Net dimensions (LxWxH), mm	1700x780x1000		1850x780x1000		2160x950x1250		2160x950x1250	
Gross dimensions (LxWxH), mm	1730x810x1020		1880x810x1020		2190x980x1270		2190x980x1270	
Net weight, kg	680		739		978		856	
Gross weight, kg	683		742		981		859	
QR code								

*Fuel consumption depends on many factors, such as load, fuel quality, season, altitude, technical condition of the generator.



Water cooling. The main advantage of the engine water cooling is the efficient removal of more heat, which helps to extend the service life power plant.



CORD REELS AND EXTENSION CABLES

Extension cord reels from Könnert & Söhne® are intended for use both indoors and outdoors, on construction sites, in agriculture, as well as in places with high humidity. Könnert & Söhne® cables are very durable and can withstand severe operating conditions and mechanical stress (shocks, fall, runover).

They are made of flexible power cord with 100% copper conductors in rubber insulation, which provides resistance to weathering, UV radiation and ozone. In addition, they are protected from chemical aggression, greases, lubricants and mineral oils. Extension cord reels are halogen-free with low smoke and low corrosive gases emission.

Total power



3000 - 3600 W

Cable length



15 - 30 M

Plug

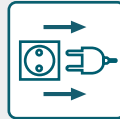

1x16 A/230 V

Sockets

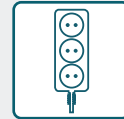

4x16 A/230 V

CABLE SPECIFICATIONS

Cable type: H07RN-F 3G2,5

H - flexible cable

07 - rated voltage 450 / 750V

R - natural or synthetic rubber insulation

N - Chloropren-Gummihülle

F - copper conductors

G - yellow-green ground wire

Number of cores - 3

Cable color - black

RESISTANCE TO EXPOSURE:

- ✓ bend resistance
- ✓ torsion resistance
- ✓ moisture resistance
- ✓ UV radiation, ozone, chemicals, greases, lubricants and mineral oils, mechanical stress

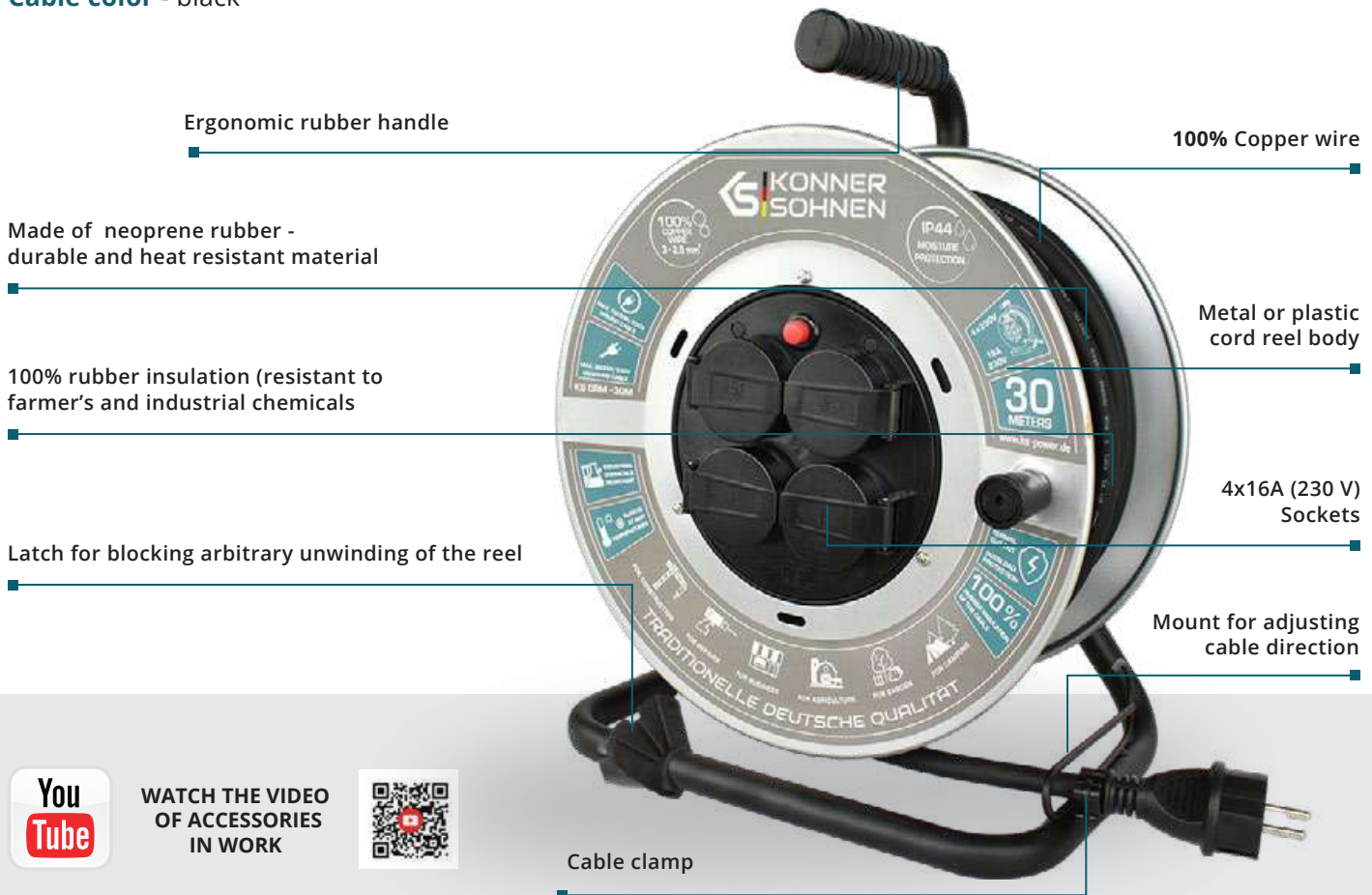

WATCH THE VIDEO OF ACCESSORIES IN WORK





KS CR-15M



KS CR-25M



KS CRM-30M

CORD REELS

Total power (unwound cable), W	3000	3600	3600
Cable length, m	15	25	30
Plug	1x16 A/230 V	1x16 A/230 V	1x16 A/230 V
Sockets with protective cap	4x16 A/230 V	4x16 A/230 V	4x16 A/230 V
Section diameter (100% copper)	3x1,5 mm ²	3x2,5 mm ²	3x2,5 mm ²
Material of extension cord reel	plastic	plastic	metal
Cable reel diameter, mm	335	380	390
Protection class	IP44		
Net weight, kg	3,2	6,5	7,8
Gross weight, kg	4	7	8,5
QR code			



KS EX1M-1S



KS EX1.5M-3S



KS EX3M-4S

SOCKET ADAPTER 32 A → 16 A

Total power (unwound cable), W	3600	5000	5000
Cable length, m	1	1,5	3
Plug	1x32 A/250 V	1x32 A/250 V	1x32 A/250 V
Sockets with protective cap	1x16 A/250 V	3x16 A/250 V	4x16 A/250 V
Section diameter (100% copper)	3x1,5 mm ²	3x2,5 mm ²	3x2,5 mm ²
Protection class	IP44		
Net weight, kg	0,36	0,7	1,45
Gross weight, kg	0,4	0,78	1,55
QR code			



Reel is equipped with a **100% copper wires**. Only copper is able to withstand long-term maximum loads, which makes the cable durable and extends its service life.



The socket adapter has a **protection class of IP44**, which allows you to use it externally, as well as at high humidity, thanks to protection against accidental ingress of water droplets and solid particles.



DISTRIBUTION BOXES

 14 – 22 kW

Distribution boxes from Könnner & Söhnen® combine high reliability, modern design, and maximum functionality. They are equipped with sockets for connecting up to 7 groups of devices with a maximum current of up to 32A and are designed for distributing electrical power at 230V/400V.

Hanging distribution boxes from Könnner & Söhnen® are equipped with the maximum level of protection. All sockets are equipped with automatic circuit breakers, and the contacts of the protective switches are made entirely of brass, eliminating the risk of galvanic corrosion. The high quality of components ensures a long service life and protects your electrical system from overloads and short circuits.

SUITABLE FOR HEAVY DUTY APPLICATIONS



Robust design



Durable ABS plastic



Increased shock resistance of the housing IK10



Corrosion protection



Reliable insulation



IP54 hermetic

High degree of protection against all kinds of environmental exposure:

- ✓ Suitable for indoor and outdoor use
- ✓ Splashproof
- ✓ Dustproof



Distribution boxes for connecting various consumers from Könnér & Söhnen® are a full-fledged device for low-voltage equipment, designed to connect various consumers. The distribution box body is made of durable corrosion-resistant ABS plastic and is noted for its reliable quality. The distribution box has a transparent cover for visual monitoring of protective circuit breakers. Easy to use and install, it is designed for wall mounting.

The distribution box is suitable for use on construction sites, in buildings, garages, agricultural buildings, etc. Consumers can be connected both inside and outside premises.

SUITABLE FOR DOMESTIC AND INDUSTRIAL APPLICATIONS



ON CONSTRUCTION



IN THE WORKSHOP



IN HOUSING



IN THE AGRICULTURAL
AND FARMING SECTOR



IN PRODUCTION



IN SERVER CENTERS

- ✓ Easy mounting
- ✓ Compact size
- ✓ Simultaneous connection to 7 groups of devices



KS DB6-P03B



KS DB11-P07B





KS DB11-P24B

Rated current, A	32	32	32
Rated operating voltage, V	230/400	230/400	230/400
Rated frequency, Hz	50/60	50/60	50/60
Capacity, kW	14	22	22
Earthing system type	TN-C-S		
Socket type	2xSchuko 230V 16A 1xCEE 230V 32A 3P	7xSchuko 230V 16A	4xSchuko 230V 16A 1xCEE 400V 32A 5P 1xCEE 400V 16A 5P
Terminal block	400V 32A, 5x6 mm ² M32	400V 32A, 5x6 mm ² M32	400V 32A, 5x6 mm ² M32
Circuit protection	1x32 A 1P(C) 2x16 A 1P(B or C)	7x16 A 1P(B or C)	1x16 A 3P(C) 1x32 A 3P(C) 4x16 A 1P(B or C)
Operating temperature	od -25 °C do +40 °C		
Impact resistance of enclosure	IK10		
Net dimensions (LxWxH), mm	135x355x140	245x355x155	245x355x155
Gross dimensions (LxWxH), mm	145x365x150	255x365x165	255x365x165
Net weight, kg	≤ 1.8	≤ 2.8	≤ 3.4
QR-код			

K&S ACCESSORIES

In the new season, we are introducing to product assortment a full range of accessories. All items are useful and sometimes even indispensable for our products. We also added a range of branded clothing. All presented items can be used both for sales and for promotional activities, customer motivation, and increased loyalty.



MOISTURE-RESISTANT AND DUSTPROOF GENERATOR COVERS

KS COVER 10

For all modifications of gasoline generators series KS 2000, 3000.

Dimensions	600x490x470 mm
------------	-----------------------

KS COVER 20



For all modifications of gasoline generators series KS 5000, KS 7000, KS 9000, KS 10000.
For all modifications of diesel generators with open frame series KS 6000, KS 8000, KS 9000.

Dimensions	740x650x550 mm
------------	-----------------------

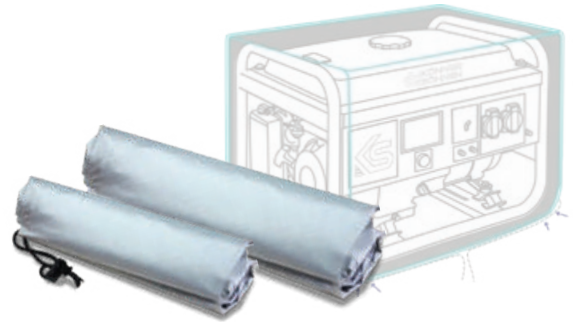

- Protects from rain, snow, sun and wind
- Resistant to ultraviolet irradiation (UV)
- Resistant to acid rain and bird droppings
- Protects from dust and dirt

FUEL CANS



	KS CAN 5	KS CAN 10
Special anti-static plastic		
Capacity	5 l	10 l
Dimensions	260x128x255 mm	330x165x300 mm



MOTOR OIL

The **motor oil** and transmission oil of the Könnner & Söhnen® brand ensures reliable protection of your motor even during continuous operation and under extreme loads, thereby considerably increasing its service life. The use of this oil in our devices ensures smooth, continuous operation.

Contains top-quality additives from the world-famous Infineum Corporation (Great Britain)

Könnner & Söhnen® 10W-30

Volume	1 l
Product quality class	API SL/CF
Class of viscosity	SAE 10W-30

ULTRA PERFORMANCE



TRANSMISSION OIL

It reduces friction in moving parts for maximum performance and efficiency, minimizes wear and tear for longer transmission life. An optimally selected composition of additives guarantees smooth operation of the mechanism and effective transmission of power, as well as ensures reliable protection against carbon, sludge and rust deposits. This oil eliminates noise and vibration during operation.



KS GEAR OIL 80W-90

Volume	1 l
Product quality class	API GL-5
Class of viscosity	SAE 80W-90

ULTRA PERFORMANCE



ANTIGEL



KS D-ANTIGEL 20/60

Könnert & Söhnen® ULTRA Performance diesel fuel anti-gel

Capacity	250 ml
Dosage	250 ml of additive per 40-60 liters of diesel fuel



- ✓ Improves low-temperature properties of diesel fuel
- ✓ Effectively reduces the pour point of diesel fuel
- ✓ Improves fuel pumpability, and enables easy engine start in cold weather
- ✓ Prevents the formation of wax crystals

DIESEL STABILIZER



KS D-STAB 60

Könnert & Söhnen® ULTRA Performance diesel fuel stabilizer

Capacity	250 ml
Dosage	250 ml of additive per 40-60 liters of diesel fuel



- ✓ Maintains the original quality of diesel during storage
- ✓ Reliably preserves the fuel system during idle hours
- ✓ Protects the fuel injection pump from corrosion and wear, even if moisture enters the system
- ✓ As well as enables easy engine start after storage

GASOLINE STABILIZER



KS G-STAB 60

Könnert & Söhnen® ULTRA Performance gasoline fuel stabilizer

Capacity	250 ml
Dosage	250 ml of additive per 40-60 liters of gasoline fuel



- ✓ Maintains the original quality of gasoline during storage
- ✓ Reliably preserves the fuel system during idle hours
- ✓ Protects the electric gasoline pump from corrosion and wear, even if moisture enters the system
- ✓ As well as enables easy engine start after storage

AUTOMATIC BATTERY CHARGER WITH AN SAE PLUG FOR LIFEPO4, AGM LEAD-ACID AND GEL BATTERIES

The easy-to-use compact charger is designed for charging LiFePo4, AGM, Lead-acid and gel batteries with a voltage of 6 V and 12 V, as well as LiFePo4 batteries with a nominal voltage of 12.8 V (4 cells). Such batteries are used in cars, light trucks, tractors, generators, vans, mobile homes, motor boats, etc., with a capacity of up to 45 Ah.



KS-B2A	
Voltage	6V/12V/12.8V
Operation mode	6V/12V/STD/GEL/AGM/LiFePO4
Rated output current	2 A
Nominal input voltage	230 V / 50 Hz
Operation temperature	-10°C +40°C
Accumulator	to 45 Ah
Cable length	1.8 m
Akumulator	85 Ah
Net dimensions (LxWxH)	92.5×65×35 mm
Net weight	0.3 kg



This automatic charger is designed for use from a power supply with a nominal voltage of 230 V. It has an SAE connector on the charge wire, which allows you to change the type of crocodile clips or ring (supplied in a set), and with the help of a special nozzle that comes with the device, you can change the polarity of the wires.

The Automatic Battery Charger is protected from

- Overheating
- Short circuit
- Reverse polarity
- Overcharge





CORDLESS SCREWDRIVER

The Könnér & Söhnen® cordless mini screwdriver is a highly convenient, portable tool suitable for a wide range of applications. It is equipped with a high-capacity 3.6 V 1300 mAh lithium-ion battery that ensures stable and long-lasting operation, reducing downtime. Thanks to its ample rotational power and high-quality battery, it can achieve up to 230 rpm and a maximum torque of 3.5 Nm.

Battery cell



3.6 V 1300 mAh

Rated Voltage



DC 3.6 V

No-load Speed



0-230 MIN⁻¹

Max. torque



3,5 Nm

✓ THE UNIQUE SWIVEL HANDLE provides comfort and convenience during work, enabling easy maneuvering in tight spaces

✓ THE INTEGRATED MAGNETIC BIT HOLDER enables quick and easy bit changes, significantly speeding up the work process

✓ COMPACT SIZE AND LIGHTWEIGHT at only 0.365 kg make it easy to carry around.



Charging socket
Charging through USB: The USB charging option makes the screwdriver mobile and ready to work in any environment where a USB port is available.

KS SD-36V	
Rated Voltage	DC 3.6 V
No-load Speed	0-230 min ⁻¹
Max. torque	3,5 Nm
Bits holder	internal hexagon ¼"
Battery cell	3.6 V 1300 mAh
Net weight	0.365 kg
Gross weight	0.55 kg
Dimensions (LxWxH)	170x50x150 mm

THE KIT INCLUDES:

- An integrated 1300 mAh lithium-ion (Li-ion) battery
- USB cable for charging (micro-USB)
- 2 screwdriver bits 50 mm each
- 11 bits of 25 mm each
- 1 holder for bits



K&S ACCESSORIES

Protective glasses



KS GL-1

Polycarbonate glasses

1 pc



Gloves



KS GLOVES L

100% leather + textile

Reliable protection against mechanical damage



Cap

CAP KS

Color

gray



T-Shirt KS

Men's (M, L, XL)

Women's (S)



Polo KS

Men's (M, L, XL)



Raglan KS

Men's (M, L, XL)



Our accessories are indispensable during technical maintenance. They provide protection and comfort during use.

Germany

DIMAX International GmbH
 info@dimaxgroup.de
 koenner-soehnen.com/de

Poland

DIMAX International
 Poland Sp. z o. o.
 info.pl@dimaxgroup.de
 konner-sohnen.com/pl

Ukraine

ТОВ "Техно Трейд КС"
 sales@ks-power.com.ua
 konner-sohnen.com/ua

France

info.fr@dimaxgroup.de
 konner-sohnen.com/fr

Spain

info.es@dimaxgroup.de
 konner-sohnen.com/es

Romania

info.ro@dimaxgroup.de
 konner-sohnen.com/ro

USA

admin.us@dimaxgroup.de
 konner-sohnen.com/en-us

Great Britain

support.uk@dimaxgroup.de
 konner-sohnen.com/en-gb

COMPANY OFFICES



OFFICIAL REPRESENTATIONS



AVAILABLE PRODUCTS

